

Schaltbilder

16. Dezember 2014

**Dachventilatoren
Entrauchungsventilatoren
Radialventilatoren
Axialventilatoren**

AIRTREND Ltd.
Predstavništvo u Beogradu
Kumanovska 14
11000 Beograd
Tel: 011 3836886, 3085740
Faks: 011 3444113
e-mail: gobrid@eunet.rs
web: www.airtrend.rs

Die Form des Klemmbrettes und die Lage der Klemmen kann von der bildlichen Darstellung abweichen.

Für den elektrischen Anschluss sind jedem Ventilator und Motor beigefügten Anschlussbilder und Inbetriebnahmevorschriften maßgebend und zu beachten.

Dieses Dokument finden Sie unter:
www.nicotra-gebhardt.com

RDA 21-....-E

RDA 31- / 32- bis Oktober 2004*

* Die Motoren wurden im Oktober 2004 umgestellt.

Bei der Auswahl von Schaltbildern für RDA 31-/32- Ventilatoren mit Baujahr 2004 bitten wir Sie Rücksprache mit Gebhardt zu halten.

Schaltbilder Zuordnung Dachventilatoren *genovent*

Ventilatorotyp	Motor Schaltbild Nr.	Revisions-schalter ESH 21-	Revisions-schalter Schaltbild Nr.
RDA 21-			
1819-2E	411	0030-22	507
1822-2E	411	0030-22	507
2225-2E	411	0030-22	507
1819-4E	411	0030-22	507
1822-4E	411	0030-22	507
2225-4E	411	0030-22	507

Schaltbilder Zuordnung Dachventilatoren *genovent*

Ventilatorotyp	Motor Schaltbild Nr.	Revisions-schalter ESH 21-	Revisions-schalter Schaltbild Nr.
RDA 31-			
RDA 32-			
2528-4E	416	21-0030-22	508
2531-4E	416	21-0030-22	508
3535-4E	416	21-0030-22	508
3540-4E	412	21-0030-25	509
3545-4E	412	21-0030-25	509
4550-4E	412	21-0030-25	509
2528-6E	416	21-0030-22	508
2531-6E	416	21-0030-22	508
3535-6E	416	21-0030-22	508
3540-6E	416	21-0030-22	508
3545-6E	416	21-0030-22	508
4550-6E	412	21-0030-25	509
4556-6E	412	21-0030-25	509
2528-4D	410	21-0030-35	503
2531-4D	410	21-0030-35	503
3535-4D	410	21-0030-35	503
3540-4D	410	21-0030-35	503
3545-4D	410	21-0030-35	503
4550-4D	410	21-0030-35	503
4556-4D	453	21-0030-35	502
2528-6D	410	21-0030-35	503
2531-6D	410	21-0030-35	503
3535-6D	410	21-0030-35	503
3540-6D	410	21-0030-35	503
3545-6D	410	21-0030-35	503
4550-6D	410	21-0030-35	503
4556-6D	410	21-0030-35	503
5663-6D	410	21-0030-35	503
5671-6D	434	21-0030-35	534
5675-6D	453	21-0075-35	502
7180-6D	455	21-0075-35	549
7190-6D	455	21-0075-35	549
4556-8D	453	21-0030-35	502
5663-8D	434	21-0030-35	534
5671-8D	434	21-0030-35	534
5675-8D	434	21-0030-35	534
7180-8D	442	21-0030-35	537
2528-MD	429	21-0030-65	515
2531-MD	429	21-0030-65	515
3535-MD	429	21-0030-65	515
3540-MD	429	21-0030-65	515
3545-MD	429	21-0030-65	515
4550-MD	429	21-0030-65	515
4556-MD	443	21-0030-65	516
2528-ND	429	21-0030-65	515
2531-ND	429	21-0030-65	515
3535-ND	429	21-0030-65	515
3540-ND	429	21-0030-65	515
3545-ND	429	21-0030-65	515
4550-ND	429	21-0030-65	515
4556-ND	429	21-0030-65	515
5663-ND	429	21-0030-65	515
5675-KD	457	21-0075-65	550
7180-KD	457	21-0075-65	550
5671-HD	441	21-0030-65	514
5675-HD	456	21-0075-65	551
7180-HD	456	21-0075-65	551

RDA 21-....-E

Schaltbilder Zuordnung Dachventilatoren

Ventilatorotyp	Motor Schaltbild Nr.	Revisions-schalter ESH 21- Nr.	Revisions-schalter Schaltbild Nr.
RDA 21-1819-2E	411	0030-22	507
RDA 21-1822-2E	411	0030-22	507
RDA 21-2225-2E	411	0030-22	507
RDA 21-1819-4E	411	0030-22	507
RDA 21-1822-4E	411	0030-22	507
RDA 21-2225-4E	411	0030-22	507

RDA 31-....-EC

Schaltbilder Zuordnung Dachventilatoren

Ventilatorotyp	Motor Schaltbild Nr.	Revisions-schalter ESH 21- Nr.	Revisions-schalter Schaltbild Nr.	Schaltbild bei Verwendung EGH 01 Nr.
RDA 21-1822-EC	-	0030-22	618	-
RDA 21-2225-EC	-	0030-22	618	-
RDA 31-2528-EC	-	0030-22	612	623
RDA 31-2531-EC	-	0030-22	612	623
RDA 31-3535-EC	-	0030-22	612	623
RDA 31-3540-EC	-	0030-22	612	623
RDA 31-3545-EC	-	0030-22	612	623
RDA 31-4550-EC	-	0030-22	612	623
RDA 31-4556-EC	-	0030-22	612	623

RGA 31-....-X

Schaltbilder Zuordnung Dachventilatoren

Ventilatorotyp	Motor Schaltbild Nr.	Revisions-schalter	Revisions-schalter Schaltbild
RGA 31-			
2528-4X-3G	444		
2528-6X-3G	445		
2531-4X-3G	444		
2531-6X-3G	445		
3535-4X-3G	444		
3535-6X-3G	445		
3540-4X-3G	445		
3540-6X-3G	445		
3545-4X-3G	445		
3545-6X-3G	445		
4550-4X-3G	445		
4550-6X-3G	445		
4556-6X-3G	445		
5663-6X-3G	445		
5671-6X-3G	445		

RDA 31-/32- ab Oktober 2004*

RGA 31- / FDA 31- / DAV 31-

Schaltbilder Zuordnung Dachventilatoren

Ventilatorotyp	Motor Schaltbild Nr.	Revisions-schalter ESH 21- Nr.	Revisions-schalter Schaltbild Nr.
RDA 31-/32- / RKA 31-/32- / RGA 31- / FDA 31- / DAV 31-			
RDA/RGA/RKA/FDA/DAV 31-2528-MD	429	21-0030-65	515
RDA/RGA/RKA/FDA/DAV 31-2528-6D	410	21-0030-35	503
RDA/RGA/RKA/FDA/DAV 31-2528-GD	441	21-0030-65	514
RDA/RGA/RKA/FDA/DAV 31-2528-4E	416	21-0030-22	508
RDA/RGA/RKA/FDA/DAV 31-2528-6E	416	21-0030-22	508
RDA/RGA/RKA/FDA/DAV 31-2531-MD	429	21-0030-65	515
RDA/RGA/RKA/FDA/DAV 31-2531-6D	410	21-0030-35	503
RDA/RGA/RKA/FDA/DAV 31-2531-GD	441	21-0030-65	514
RDA/RGA/RKA/FDA/DAV 31-2531-4E	416	21-0030-22	508
RDA/RGA/RKA/FDA/DAV 31-2531-6E	416	21-0030-22	508
RDA/RGA/RKA/FDA/DAV 31-3535-MD	429	21-0030-65	515
RDA/RGA/RKA/FDA/DAV 31-3535-ND	429	21-0030-65	515
RDA/RGA/RKA/FDA/DAV 31-3535-GD	441	21-0030-65	514
RDA/RGA/RKA/FDA/DAV 31-3535-4E	416	21-0030-22	508
RDA/RGA/RKA/FDA/DAV 31-3535-6E	416	21-0030-22	508
RDA/RGA/RKA/FDA/DAV 31-3540-MD	429	21-0030-65	515
RDA/RGA/RKA/FDA/DAV 31-3540-ND	429	21-0030-65	515
RDA/RGA/RKA/FDA/DAV 31-3540-GD	441	21-0030-65	514
RDA/RGA/RKA/FDA/DAV 31-3540-4E	412	21-0030-25	509
RDA/RGA/RKA/FDA/DAV 31-3540-6E	416	21-0030-22	508
RDA/RGA/RKA/FDA/DAV 31-3545-MD	429	21-0030-65	515
RDA/RGA/RKA/FDA/DAV 31-3545-ND	429	21-0030-65	515
RDA/RGA/RKA/FDA/DAV 31-3545-GD	441	21-0030-65	514
RDA/RGA/RKA/FDA/DAV 31-3545-4E	412	21-0030-25	509
RDA/RGA/RKA/FDA/DAV 31-3545-6E	416	21-0030-22	508
RDA/RGA/RKA/FDA/DAV 31-4550-MD	429	21-0030-65	515
RDA/RGA/RKA/FDA/DAV 31-4550-ND	429	21-0030-65	515
RGA/RKA/FDA/DAV 31-4550-8D	453	21-0030-35	502
RDA/RGA/RKA/FDA/DAV 31-4550-GD	441	21-0030-65	514
RDA/RGA/RKA/FDA/DAV 31-4550-4E	412	21-0030-25	509
RDA/RGA/RKA/FDA/DAV 31-4550-6E	412	21-0030-25	509
RDA/RGA/RKA/FDA/DAV 31-4556-MD	443	21-0030-65	516
RDA/RGA/RKA/FDA/DAV 31-4556-ND	429	21-0030-65	515
RDA/RGA/RKA/FDA/DAV 31-4556-8D	453	21-0030-35	502
RDA/RGA/RKA/FDA/DAV 31-4556-GD	441	21-0030-65	514
RDA 31-4556-6E	412	21-0030-25	509
RDA/RGA/RKA/FDA/DAV 31-5663-ND	429	21-0030-65	515
RDA/RGA/RKA/FDA/DAV 31-5663-8D	453	21-0030-35	502
RGA/RKA/FDA/DAV 31-5663-HD	441	21-0030-65	514
RDA/RGA/RKA/FDA/DAV 31-5671-ND	443	21-0030-65	516
RDA/RGA/RKA/FDA/DAV 31-5671-8D	453	21-0030-35	502
RDA/RGA/RKA/FDA/DAV 31-5671-HD	441	21-0030-65	514
RDA/RGA/RKA/FDA/DAV 31-5675-6D	453	21-0075-35	502
RDA/RGA/RKA/FDA/DAV 31-5675-8D	434	21-0030-35	527
RDA/RGA/RKA/FDA/DAV 31-5675-HD	456	21-0075-65	551
RDA 31-5675-KD	457	21-0075-65	550
RDA/RGA/RKA/FDA/DAV 31-7180-6D	455	21-0075-35	549
RDA/RGA/RKA/FDA/DAV 31-7180-8D	453	21-0030-35	502
RDA/RGA/RKA/FDA/DAV 31-7180-HD	456	21-0075-65	551
RDA 31-7180-KD	457	21-0075-65	550
RDA/RGA/RKA/FDA/DAV 31-7190-6D	455	21-0075-35	549

RDM 31-/32-....-.D

Schaltbilder Zuordnung Dachventilatoren

Ventilatorotyp RDM 31- RDM 32-	Motor Schaltbild Nr.	Klemmenkasten Schaltbild Nr.	Revisions- schalter ESH 21-	Revisions-schalter Schaltbild Nr.
2528-2D-10	–	477	0030-32	557
2528-4D-04	–	477	0030-32	557
2531-4D-05	–	477	0030-32	557
3535-4D-07	–	477	0030-32	557
3540-4D-10	–	477	0030-32	557
3545-4D-11	–	477	0030-32	557
4550-4D-14	474	–	0030-32	557
4556-4D-17	474	–	0055-32	558
5663-4D-21	474	–	0075-62	559
9090-4D-31	474	–	0220-62	543
2528-6D-04	–	477	0030-32	557
2531-6D-04	–	477	0030-32	557
3535-6D-07	–	477	0030-32	557
3540-6D-07	–	477	0030-32	557
3545-6D-08	–	477	0030-32	557
4550-6D-10	474	–	0030-32	557
4556-6D-13	474	–	0030-32	557
5663-6D-16	474	–	0030-32	557
5671-6D-19	474	–	0055-32	558
7180-6D-23	474	–	0075-62	559
7190-6D-26	474	–	0110-62	559
4556-8D-13	474	–	0030-32	557
5663-8D-14	474	–	0030-32	557
5671-8D-17	474	–	0030-32	557
7180-8D-21	474	–	0055-32	558
7190-8D-23	474	–	0055-32	558
3540-ID-11	–	478	0030-62	560
3545-ID-13	–	478	0030-62	560
4550-ID-16	475	–	0030-62	560
4556-ID-19	475	–	0075-62	561
5663-ID-23	475	–	0075-62	561
9090-ID-34	475	–	0300-62	545
4550-KD-13	421	–	0030-62	531
4556-KD-16	421	–	0030-62	531
5663-KD-19	421	–	0030-62	531
5671-KD-24	421	–	0075-62	520
7180-KD-26	421	–	0075-62	520
3540-GD-10	–	479	0030-62	562
3545-GD-13	–	479	0030-62	562
4550-GD-14	476	–	0030-62	562
4556-GD-17	476	–	0030-62	562
5663-GD-23	476	–	0075-62	563
9090-GD-34	476	–	0300-62	544
3545-HD-10	–	438	0030-62	530
4550-HD-14	422	–	0030-62	530
4556-HD-16	422	–	0030-62	530
5663-HD-19	422	–	0030-62	530
5671-HD-24	422	–	0075-62	519
7180-HD-23	422	–	0075-62	519
7190-HD-26	422	–	0110-62	519

RDM 30-....-.A

Schaltbilder Zuordnung Dachventilatoren

Ventilatorotyp RDM 31- RDM 32-	Motor Schaltbild Nr.	Klemmenkasten Schaltbild Nr.	Revisions- schalter ESH 21-	Revisions-schalter Schaltbild Nr.
2528-2A-10	–	431	0030-35	505
2528-4A-04	–	480	0030-32	564
2531-4A-05	–	480	0030-32	564
3535-4A-07	–	480	0030-32	564
3540-4A-11	–	431	0030-35	505
3545-4A-13	–	431	0030-35	505
4550-4A-16	430	–	0030-35	505
4556-4A-17	430	–	0030-35	505
2528-6A-04	–	480	0030-32	564
2531-6A-04	–	480	0030-32	564
3535-6A-07	–	480	0030-32	564
3540-6A-07	–	480	0030-32	564
3545-6A-08	–	480	0030-32	564
4550-6A-10	420	–	0030-32	564
4556-6A-13	430	–	0030-35	505
5663-6A-16	420	–	0030-32	564
4556-8A-13	420	–	0030-32	564
5663-8A-14	420	–	0030-32	564
5671-8A-17	420	–	0030-32	564

RDM 30-....-FU

Schaltbilder Zuordnung Dachventilatoren

Ventilatorotyp RDM 31- RDM 32-	ohne Revisions-schalter ohne Klemmenkasten Schaltbild Nr.	ohne Revisions-schalter mit Klemmenkasten Schaltbild Nr.	Revisions- schalter ESH 21-	Revisions- schalter Schaltbild Nr.
2528-4D-04-FU	601	602	0030-22	600
2531-4D-05-FU	601	602	0030-22	600
3535-4D-07-FU	601	602	0030-22	600
3540-6D-07-FU	601	602	0032-22	600
3545-6D-08-FU	601	602	0030-22	600
4550-6D-10-FU	601	602	0030-22	600
4556-8D-13-FU	601	602	0032-22	600

RDM 30-....-X

Schaltbilder Zuordnung Dachventilatoren

Ventilatorotyp RDM 31- RDM 32-	Motor Schaltbild Nr.	Klemmenkasten Schaltbild Nr.	Revisions- schalter ESH 21-	Revisions-schalter Schaltbild Nr.
2528-4X-04	402	–	–	–
2531-4X-05	402	–	–	–
3535-4X-07	402	–	–	–
3540-4X-10	402	–	–	–
3545-4X-13	402	–	–	–
4550-4X-14	420	–	–	–
4556-4X-17	420	–	–	–
5663-4X-21	420	–	–	–
3540-6X-08	402	–	–	–
3545-6X-08	402	–	–	–
4550-6X-10	420	–	–	–
4556-6X-14	420	–	–	–
5663-6X-19	420	–	–	–
5671-6X-21	420	–	–	–
7180-6X-24	420	–	–	–

BelAir timer

RDA 21-/31-....-ST

Schaltbilder Zuordnung BelAir

Ventilatorotyp	Motor Schaltbild Nr.	Revisions- schalter ESH 21-	Revisions- schalter Schaltbild Nr.
RDA timer			
RDA 21-1819-2E-ST	–	0030-22	604
RDA 21-1822-2E-ST	–	0030-22	604
RDA 21-2225-2E-ST	–	0030-22	604
RDA 21-1819-4E-ST	–	0030-22	604
RDA 21-1822-4E-ST	–	0030-22	604
RDA 21-2225-4E-ST	–	0030-22	604
RDA 31-2528-4E-ST	–	0030-22	604
RDA 31-2531-4E-ST	–	0030-22	604
RDA 31-3535-4E-ST	–	0030-22	604
RDA 31-3540-4E-ST	–	0030-25	605
RDA 31-3545-4E-ST	–	0030-25	605
RDA 31-2528-6E-ST	–	0030-22	604
RDA 31-2531-6E-ST	–	0030-22	604
RDA 31-3535-6E-ST	–	0030-22	604
RDA 31-3540-6E-ST	–	0030-22	604
RDA 31-3545-6E-ST	–	0030-22	604
RDA 31-2528-EC-ST	–	0030-22	615
RDA 31-2531-EC-ST	–	0030-22	615
RDA 31-3535-EC-ST	–	0030-22	615
RDA 31-3540-EC-ST	–	0030-25	615

RVM F1**Schaltbilder Zuordnung Dachventilatoren**

Ventilatorotyp	Motor Schaltbild Nr.	Klemmenkasten Nr.	Revisions- schalter ESH-21	Revisions- schalter Schaltbild Nr.
RVM F1				
2528-4D-04	420	–	0030-32	557
2531-4D-04	420	–	0030-32	557
3535-4D-05	420	–	0030-32	557
3540-4D-08	420	–	0030-32	557
3545-4W-11	420	–	0030-32	557
4550-4W-14	420	–	0030-32	557
4556-4W-16	420	–	0030-32	557
4556-6D-11	420	–	0030-32	557
5663-6W-14	420	–	0030-32	557
5671-6W-19	420	–	0030-32	557
7180-6W-23	420	–	0075-62	559
7190-6W-26	420	–	0110-62	559
7180-8D-19	420	–	0030-32	557
7190-8D-23	420	–	0055-62	559

BelAir pressure

RDA 21-/31-....-SE

RDM 31-....-FU-SE

Schaltbilder Zuordnung BelAir

Ventilatorotyp	Motor Schaltbild Nr.	Revisions- schalter ESH 21-	Revisions- schalter Schaltbild Nr.
RDA pressure			
RDM pressure			
RDA 21-1819-2E-SE	–	0030-22	606
RDA 21-1822-2E-SE	–	0030-22	606
RDA 21-2225-2E-SE	–	0030-22	606
RDA 21-1819-4E-SE	–	0030-22	606
RDA 21-1822-4E-SE	–	0030-22	606
RDA 21-2225-4E-SE	–	0030-22	606
RDA 31-2528-4E-SE	–	0030-22	607
RDA 31-2531-4E-SE	–	0030-22	607
RDA 31-3535-4E-SE	–	0030-22	607
RDA 31-3540-4E-SE	–	0030-22	607
RDA 21-1822-EC-SE	–	0030-22	619
RDA 21-2225-EC-SE	–	0030-22	619
RDA 31-2528-EC-SE	–	0030-22	620
RDA 31-2531-EC-SE	–	0030-22	620
RDA 31-3535-EC-SE	–	0030-22	620
RDA 31-3540-EC-SE	–	0030-22	620
RDM 31-2528-4D-FU-SE	–	0030-22	610
RDM 31-2531-4D-FU-SE	–	0030-22	610
RDM 31-3535-4D-FU-SE	–	0030-22	610
RDM 31-3540-6D-FU-SE	–	0030-22	610
RDM 31-3545-6D-FU-SE	–	0030-22	610

BelAir automatic

RDA 21-/31-....-SA

RDM31-....-FU-SA

Schaltbilder Zuordnung BelAir

Ventilatorotyp	Motor Schaltbild Nr.	Revisions- schalter ESH 21-	Revisions- schalter Schaltbild Nr.
RDA automatic			
RDM automatic			
RDA 21-1822-EC-SA	–	0030-22	617
RDA 21-2225-EC-SA	–	0030-22	617
RDA 31-2528-EC-SA	–	0030-22	612
RDA 31-2531-EC-SA	–	0030-22	612
RDA 31-3535-EC-SA	–	0030-22	612
RDA 31-3540-EC-SA	–	0030-22	612
RDM 31-2528-4D-FU-SA	–	0030-22	600
RDM 31-2531-4D-FU-SA	–	0030-22	600
RDM 31-3535-4D-FU-SA	–	0030-22	600
RDM 31-3540-6D-FU-SA	–	0030-22	600
RDM 31-3545-6D-FU-SA	–	0030-22	600

DAV | DA

DAV | DA

Schaltbilder Zuordnung Dachventilatoren

Ventilator- typ DA DAV	Motor Schaltbild- Nr.	Revisions- schalter ESH 21-	Revisions- schalter Schaltbild Nr.
DA/DAV 225-4	410	0030-35	503
DA/DAV 225-6	410	0030-35	503
DA/DAV 225-8	425	0030-35	505
DA/DAV 225-4/4	429	0030-65	515
DA/DAV 225-6/6	428	0030-65	506
DA/DAV 225-4/6	417	0030-65	512
DA/DAV 225-4/8	418	0030-65	514
DA/DAV 225-6/12	409	0030-65	513
DA/DAV 225-4ex	406	–	–
DA/DAV 225-6ex	406	–	–
DAe/DAVe 225-4	416	0030-22	508
DAe/DAVe 225-6	416	0030-22	508
DAe/DAVe 225-8	427	0030-22	508
DAe/DAVe 225-4/4	415	0030-62	526
DAe/DAVe 225-6/6	415	0030-62	526
DA/DAV 315-4	410	0030-35	503
DA/DAV 315k-4	410	0030-35	503
DA/DAV 315-6	410	0030-35	503
DA/DAV 315-8	425	0030-35	505
DA/DAV 315-4/4	429	0030-65	515
DA/DAV 315-6/6	429	0030-65	515
DA/DAV 315-4/6	417	0030-65	512
DA/DAV 315-4/8	418	0030-65	514
DA/DAV 315-6/12	409	0030-65	513
DA/DAV 315-4ex	406	–	–
DA/DAV 315-6ex	406	–	–
DAe/DAVe 315-4	416	0030-22	508
DAe/DAVe 315-6	416	0030-22	508
DAe/DAVe 315-8	427	0030-22	508

Schaltbilder Zuordnung Dachventilatoren

Ventilator- typ DA DAV	Motor Schaltbild- Nr.	Revisions- schalter ESH 21-	Revisions- schalter Schaltbild Nr.
DA/DAV 400-4	410	0030-35	503
DA/DAV 400-6	410	0030-35	503
DA/DAV 400-8	425	0030-35	505
DA/DAV 400-4/4	429	0030-65	515
DA/DAV 400-6/6	429	0030-65	515
DA/DAV 400-4/6	417	0030-65	512
DA/DAV 400-4/8	418	0030-65	514
DA/DAV 400-6/12	409	0030-65	513
DA/DAV 400-4ex	406	–	–
DA/DAV 400-6ex	406	–	–
Dae/DAVe 400-4	412	0030-35	509
Dae/DAVe 400-6	416	0030-35	508
DA/DAV 450-4	410	0030-35	503
DA/DAV 450-6	410	0030-35	503
DA/DAV 450-8	425	0030-35	505
DA/DAV 450-4/4	429	0030-65	515
DA/DAV 450-6/6	429	0030-65	515
DA/DAV 450-4/6	417	0030-65	512
DA/DAV 450-4/8	418	0030-65	514
DA/DAV 450-6/12	418	0030-65	514
DA/DAV 450-4ex	406	–	–
DA/DAV 450-6ex	406	–	–
DAe/DAVe 450-6	412	0030-35	509
DA/DAV 560k-4	425	0075-35	523
DA/DAV 560-6	410	0030-35	503
DA/DAV 560k-6	410	0030-35	503
DA/DAV 560-8	434	0030-35	534
DA/DAV 560-6/6	429	0030-65	515
DA/DAV 560-6/12	418	0030-65	514
DA/DAV 560-6ex	406	–	–
DA/DAV 630s-6	426	0075-35	523
DA/DAV 630-6	434	0030-35	534
DA/DAV 630-8	434	0030-35	534
DA/DAV 630-6/12	418	0030-65	514
DA/DAV 630-6ex	406	–	–
DA/DAV 710-6	426	0075-35	523
DA/DAV 710-8	426	0075-35	523
DA/DAV 710-6/12	418	0075-65	514

RDM 56

RDM 57

RWM 57

Schaltbilder Zuordnung Entrauchungsventilatoren

Ventilator- typ	Motor Schaltbild Nr.	Revisions- schalter ESH 23- Nr.	Revisions- schalter Schaltbild Nr.
RDM 56- RDM 57-			
2528-2D-11	402	0055-32	517
2528-4D-10	402	0055-32	517
2531-4D-10	402	0055-32	517
3535-4D-10	402	0055-32	517
3540-4D-10	402	0055-32	517
3545-4D-13	402	0055-32	517
4550-4D-16	402	0055-32	517
4556-4D-17	402	0055-32	517
5663-4D-23	403	0075-32	518
9090-4D-31	446	0220-62	543+446
3535-6D-10	402	0055-32	517
3540-6D-10	402	0055-32	517
3545-6D-10	402	0055-32	517
4550-6D-11	402	0055-32	517
4556-6D-13	402	0055-32	517
5663-6D-16	402	0055-32	517
5671-6D-21	402	0055-32	517
7180-6D-24	403	0075-62	518
7190-6D-28	403	0110-62	518
7180-8D-21	402	0055-32	517
7190-8D-26	403	0075-62	518
3535-ID-10	404	0075-62	520
3540-ID-11	404	0075-62	520
3545-ID-14	404	0075-62	520
4550-ID-16	404	0075-62	520
9090-ID-34	450	0300-62	545+450
4550-KD-13	404	0075-62	520
4556-KD-16	404	0075-62	520
5663-KD-19	404	0075-62	520
5671-KD-24	404	0075-62	520
7180-KD-26	404	0075-62	520
3535-GD-10	405	0075-62	519
3540-GD-10	405	0075-62	519
3545-GD-13	405	0075-62	519
4550-GD-14	405	0075-62	519
4556-GD-19	405	0075-62	519
9090-GD-34	451	0300-62	544+451
3545-HD-10	405	0075-62	519
4550-HD-14	405	0075-62	519
4556-HD-16	405	0075-62	519
5663-HD-19	405	0075-62	519
5671-HD-24	405	0075-62	519
7180-HD-28	405	0075-62	519
7190-HD-26	405	0110-62	519

Schaltbilder Zuordnung Entrauchungsventilatoren

Ventilator- typ	Motor Schaltbild Nr.	Revisions- schalter ESH 23- Nr.	Revisions- schalter Schaltbild Nr.
RWM 57-			
2528-2D-11	402	0055-32	517
2528-4D-10	402	0055-32	517
3540-4D-10	402	0055-32	517
3540-6D-10	402	0055-32	517
3540-GD-10	405	0075-62	519
3540-ID-11	404	0075-62	520
4045-4D-13	402	0055-32	517
4045-6D-10	402	0055-32	517
4045-GD-13	405	0075-62	519
4045-ID-14	404	0075-62	520
4045-HD-11	405	0075-62	519
4550-4D-16	402	0055-32	517
4550-6D-11	402	0055-32	517
4550-GD-14	405	0075-62	519
4550-ID-16	404	0075-62	520
4550-HD-14	405	0075-62	519
5056-4D-17	402	0055-32	517
5056-6D-13	402	0055-32	517
5056-GD-19	405	0075-62	519
5056-HD-16	405	0075-62	519
5056-KD-16	405	0075-62	519
5663-6D-16	402	0055-32	517
5663-HD-19	405	0075-62	519
5663-KD-19	404	0075-62	520
6371-6D-21	402	0055-32	517
5671-HD-24	405	0075-62	519
5671-KD-24	404	0075-62	520
7180-6D-24	403	0075-62	518
7180-8D-21	402	0055-32	517
7180-HD-28	405	0075-62	519
7180-KD-26	404	0075-62	520
8090-6D-28	403	0110-62	518
7190-8D-26	403	0075-62	518

REM BU

Schaltbilder Zuordnung Entrauchungsventilatoren

Ventilator- typ	Motor Schaltbild Nr.	Revisions- schalter ESH 21- Nr.	Revisions- schalter Schaltbild Nr.
REM BU-			
2528-2D-10	448	0055-32	555
2528-4D-10	448	0055-32	555
2528-FD-10	461	0055-62	554
3135-2D-14	448	0055-32	555
3135-4D-10	448	0055-32	555
3135-FD-14	461	0055-62	554
4045-4D-11	448	0055-32	555
4045-ID-14	460	0055-62	553
4045-GD-11	461	0055-62	554
4550-4D-14	448	0055-32	555
4550-ID-17	460	0055-62	553
4550-GD-14	461	0055-62	554
5056-4D-16	448	0055-32	555
5056-ID-21	460	0055-62	553
5056-GD-21	461	0055-62	554
5663-4D-19	448	0075-62	556
5663-ID-26	460	0075-62	553
5663-GD-26	461	0110-62	554
6371-4D-23	448	0075-62	556
6371-ID-28	460	0150-62	553
6371-GD-28	461	0150-62	554
7180-6D-23	448	0075-62	556
8090-6D-26	448	0075-62	556

SLCS / 300°C – 120 min.

Schaltbilder Zuordnung Entrauchungsventilatoren

Ventilator- typ	Motor Schaltbild Nr.	Revisions- schalter ESH 21-	Revisions- schalter Schaltbild Nr.
SLCS			
400/2-3A	420	-	-
400/2-3B	420	-	-
400/2-3C	420	-	-
400/4-3	420	-	-
500/2-3A	420	-	-
500/2-3B	420	-	-
500/2-3C	420	-	-
GV500/2-3C	420	-	-
500/4-3A	420	-	-
500/4-3C	420	-	-
560/2-3C	420	-	-
GV560/2-3C	420	-	-
560/4-3A	420	-	-
560/4-3B	420	-	-
630/2-3E	420	-	-
GV630/2-3E	420	-	-
630/2-3F	420	-	-
GV630/2-3F	420	-	-
630/2-3G	420	-	-
GV630/2-3G	420	-	-
630/4-3C	420	-	-
630/4-3D	420	-	-
710/2-3C	420	-	-
GV710/2-3C	420	-	-
710/4-3A	420	-	-
710/4-3B	420	-	-
800/4-3A	420	-	-
800/4-3B	420	-	-
800/4-3C	420	-	-
GV800/4-3C	420	-	-
800/4-3D	420	-	-
GV800/4-3D	420	-	-
1000/4-3A	420	-	-
1000/4-3B	420	-	-
1000/4-3C	420	-	-
GV1000/4-3C	420	-	-
1000/4-3D	420	-	-
GV1000/4-3D	420	-	-
1000/4-3E	420	-	-
GV1000/4-3E	420	-	-
1000/4-3F	420	-	-
GV1000/4-3F	420	-	-

AGM / 300°C – 120 min.

Schaltbilder Zuordnung Entrauchungsventilatoren

Ventilator- typ	Motor Schaltbild Nr.	Revisions- schalter ESH 23-	Revisions- schalter Schaltbild Nr.
AGM			
01-/02-/11-/12-			
0315-2D-10	472	-	-
0315-2D-11	472	-	-
0315-FD-11	473	-	-
0400-2D-11	472	-	-
0400-FD-11	473	-	-

AGM / CO

Schaltbilder Zuordnung Jetfans

Ventilator- typ	Motor Schaltbild Nr.	Revisions- schalter ESH 21-	Revisions- schalter Schaltbild Nr.
AGM			
06-/16-			
0315-2D-10	483	-	-
0400-2D-11	483	-	-
0315-2D-10-FU	485	-	-
0400-2D-11-FU	485	-	-
0315-FD-11	484	-	-
0400-FD-11	484	-	-

SLCS / 400°C – 120 min.

Schaltbilder Zuordnung Entrauchungsventilatoren

Ventilator- typ	Motor Schaltbild Nr.	Revisions- schalter ESH 21-	Revisions- schalter Schaltbild Nr.
SLCS			
400/2-3U	420	-	-
GV400/2-3U	420	-	-
400/2-3V	420	-	-
GV400/2-3V	420	-	-
400/4-3T	420	-	-
GV400/4-3T	420	-	-
500/4-3T	420	-	-
GV500/4-3T	420	-	-
500/4-3U	420	-	-
GV500/4-3U	420	-	-
560/4-3T	420	-	-
GV560/4-3T	420	-	-
560/4-3U	420	-	-
GV560/4-3U	420	-	-
630/2-3T	420	-	-
GV630/4-3T	420	-	-
630/4-3U	420	-	-
GV630/4-3U	420	-	-
710/4-3T	420	-	-
GV710/4-3T	420	-	-
710/4-3U	420	-	-
GV710/4-3U	420	-	-
800/4-3T	420	-	-
GV800/4-3T	420	-	-
800/4-3U	420	-	-
GV800/4-3U	420	-	-
1000/4-3T	420	-	-
GV1000/4-3T	420	-	-
1000/4-3U	420	-	-
GV1000/4-3U	420	-	-
1000/4-3V	420	-	-
GV1000/4-3V	420	-	-

RGM / 300°C – 120 min.

Schaltbilder Zuordnung Entrauchungsventilatoren

Ventilator- typ	Motor Schaltbild Nr.	Revisions- schalter ESH 23-	Revisions- schalter Schaltbild Nr.
RGM			
91-			
0600-4D-15	486	-	-
0610-4D-16	486	-	-
0600-ID-15	487*	-	-
0610-ID-16	487*	-	-
0600-GD-15	487	-	-
0610-GD-16	487	-	-

* Motor in PAM-Schaltung, Anschluss analog Dahlander

RGM / CO

Schaltbilder Zuordnung Jetfans

Ventilator- typ	Motor Schaltbild Nr.	Revisions- schalter ESH 21-	Revisions- schalter Schaltbild Nr.
RGM			
96-			
0600-4D-15	488	0030-32	568
0610-4D-16	488	0030-32	568
0600-4D-15-FU	490	0030-32	-
0610-4D-16-FU	490	0030-32	-
0600-ID-15	489*	0030-32	569
0610-ID-16	489*	0030-32	569
0600-GD-15	489	0030-32	569
0610-GD-16	489	0030-32	569

* Motor in PAM-Schaltung, Anschluss analog Dahlander

TZA

Schaltbilder Zuordnung Radialventilatoren

Ventilator typ	Motor Schaltbild Nr.	Revisions-schalter ESH 21-	Revisionsschalter Schaltbild Nr.
TZA E1-0080-2E	411	0030-22	507
TZA E1-0112-2E	411	0030-22	507
TZA E1-0112-4E	411	0030-22	507
TZA E1-0130-4E	411	0030-22	507
TZA 01-0200-4E	412	0030-25	509
TZA 01-0200-4D	410	0030-65	515
TZA 94-0215-4E	412	0030-35	509
TZA 01-0225-4E	412	0030-25	509
TZA 01-0225-4D	410	0030-65	515
TZA 61-0225-4E	412	0030-25	509
TZA 61-0225-4D	410	0030-65	515
TZA 01-0250-4E	412	0030-25	509
TZA 01-0250-4D	410	0030-65	515
TZA 61-0250-4E	412	0030-25	509
TZA 61-0250-4D	410	0030-65	515
TZA 01-0280-4E	412	0030-25	509
TZA 01-0280-4D	410	0030-65	515
TZA 01-0280-6D	410	0030-65	515
TZA 61-0280-4E	412	0030-25	509
TZA 61-0280-4D	410	0030-65	515
TZA 01-0315-4D	410	0075-65	515
TZA 01-0315-6D	410	0030-65	515
TZA 01-0355-4D	410	0075-65	515
TZA 01-0355-6D	410	0030-65	515

TBA

Schaltbilder Zuordnung fanbox

Ventilator typ	Motor Schaltbild Nr.	Revisions-schalter ESH 21-	Revisionsschalter Schaltbild Nr.
TBA E1-0112-2E	411	0030-22	507
TBA E1-0130-4E	411	0030-22	507
TBA 01-0200-4E	412	0030-25	509
TBA 01-0225-4E	412	0030-25	509
TBA 01-0250-4E	412	0030-25	509
TBA 01-0280-4E	412	0030-25	509

RZA

Schaltbilder Zuordnung Radialventilatoren

Ventilator typ	Motor Schaltbild LG/RD Nr.
RZA 11-0225-4D	401/400
RZA 11-0250-4D	401/400
RZA 11-0280-4D	400/401
RZA 11-0315-4D	400/401
RZA 11-0355-4D	400/401
RZA 11-0400-4D	400/401
RZA 11-0450-4D	400/401
RZA 11-0500-6D	400/401
RZA 11-0560-6D	401/400

RBA

Schaltbilder Zuordnung fanbox

Ventilator typ	Motor Schaltbild LG/RD Nr.	Revisions-schalter ESH 21-	Revisionsschalter Schaltbild Nr.
RBA 11-0225-4D	401/400	–	–
RBA 11-0250-4D	401/400	–	–
RBA 11-0280-4D	400/401	–	–
RBA 21-1822-EC	–	0030-22	618
RBA 21-1822-EC-SA	–	0030-22	617
RBA 21-1822-EC-SE	–	0030-22	619
RBA 21-2225-EC	–	0030-22	618
RBA 21-2225-EC-SA	–	0030-22	617
RBA 21-2225-EC-SE	–	0030-22	619

TEM

Schaltbilder Zuordnung Radialventilatoren

Ventilatorotyp	Motor Schaltbild LG/RD	Revisions- schalter	Revisionschalter Schaltbild LG/RD
TEM 01- TEM 08-	Nr.	ESH 21-	Nr.
0160-2D-08	424/420	0030-32	539/528
0160-4D-05	424/420	0032-32	539/528
0180-2D-11	424/420	0030-32	539/528
0180-4D-05	424/420	0030-32	539/528
0200-2D-14	424/420	0030-32	539/528
0200-4D-08	424/420	0030-32	539/528
0225-2D-19	424/420	0075-62	538/518
0225-2D-14	424/420	0030-32	539/528
0225-4D-11	424/420	0030-32	539/528
0250-2D-19	424/420	0075-62	538/518
0250-4D-13	424/420	0030-32	539/528
0250-4D-11	424/420	0030-32	539/528
0250-6D-08	424/420	0030-32	539/528
0280-4D-16	424/420	0030-32	539/528
0280-4D-13	424/420	0030-32	539/528
0280-6D-11	424/420	0030-32	539/528
0315-4D-19	424/420	0075-62	538/518
0315-4D-16	424/420	0030-32	539/528
0315-6D-14	424/420	0030-32	539/528
0355-4D-19	424/420	0075-62	538/518
0355-6D-19	424/420	0030-32	539/528
0160-2X-08	424/420	–	–
0160-4X-05	424/420	–	–
0180-2X-11	424/420	–	–
0180-4X-05	424/420	–	–
0200-2X-14	424/420	–	–
0200-4X-08	424/420	–	–
0225-2X-19	424/420	–	–
0225-4X-11	424/420	–	–
0250-2X-19	424/420	–	–
0250-4X-13	424/420	–	–
0280-4X-16	424/420	–	–
0315-4X-19	424/420	–	–
0355-4X-19	424/420	–	–

TEA

Schaltbilder Zuordnung Radialventilatoren

Ventilatorotyp	Motor Schaltbild LG/RD	Revisions- schalter	Revisionschalter Schaltbild LG/RD
TEA	Nr.	ESH 21-	Nr.
TEA E1-0060-2E	414	0030-22	565
TEA E1-0090-2E	411	0030-22	507
TEA E1-0100-2E	411	0030-22	507
TEA E1-0125-2E	411	0030-22	507
TEA E1-0130-2E	411	0030-22	507
TEA E1-0150-2E	411	0030-22	507
TEA 01-0200-4E	413/412	0030-25	566/509
TEA 01-0225-4E	413/412	0030-25	566/509
TEA 01-0250-4E	413/412	0030-25	566/509
TEA 01-0280-4E	413/412	0030-25	566/509
TEA F1-0225-4E	413/412	0030-25	566/509
TEA F1-0250-4E	413/412	0030-25	566/509
TEA F1-0280-4E	413/412	0030-25	566/509
TEA F1-0315-4E	413/412	0030-25	566/509
TEA F1-0355-4E	413/412	0030-25	566/509
TEA 01-0200-4D	419/410	0030-35	527/503
TEA 01-0225-4D	419/410	0030-35	527/503
TEA 01-0250-4D	419/410	0030-35	527/503
TEA 01-0280-4D	419/410	0030-35	527/503
TEA 01-0315-4D	419/410	0030-35	527/503

REM

Schaltbilder Zuordnung Radialventilatoren

Ventilatorotyp	Motor Schaltbild LG/RD	Revisions- schalter	Revisionschalter Schaltbild LG/RD
REM 11-/13- REM 18-/19-	Nr.	ESH 21-	Nr.
0200-2D-07	424/420	0030-32	539/528
0225-2D-07	424/420	0030-32	539/528
0250-2D-08	424/420	0030-32	539/528
0280-2D-11	424/420	0030-32	539/528
0315-2D-13	424/420	0030-32	539/528
0315-4D-07	424/420	0030-32	539/528
0355-2D-16	424/420	0055-32	540/517
0355-4D-08	424/420	0030-32	539/528
0400-2D-21	424/420	0075-62	538/518
0400-4D-10	424/420	0030-32	539/528
0450-4D-13	424/420	0030-32	539/528
0500-4D-16	424/420	0030-32	539/528
0500-6D-11	424/420	0030-32	539/528
0560-4D-19	424/420	0075-62	538/518
0560-6D-14	424/420	0030-32	539/528
0630-4D-23	424/420	0075-62	538/518
0630-6D-19	424/420	0030-32	539/528
0200-2X-07	424/420	–	–
0225-2X-07	424/420	–	–
0250-2X-08	424/420	–	–
0280-2X-11	424/420	–	–
0315-2X-14	424/420	–	–
0315-4X-07	424/420	–	–
0355-2X-19	424/420	–	–
0355-4X-08	424/420	–	–
0400-2X-22	424/420	–	–
0400-4X-11	424/420	–	–
0450-4X-13	424/420	–	–
0500-4X-16	424/420	–	–
0560-4X-19	424/420	–	–
0630-4X-23	424/420	–	–

RLM-Evo RLM E6-.W

Achtung: Anschlussart auf dem Motortypenschild beachten!

Schaltbilder Zuordnung Ventilatormodule

Ventilatortyp	Anschlussart	Motor Schaltbild Nr.	Revisions-schalter ESH 21-	Revisions-schalter Schaltbild Nr.
RLM E6-				
2528-2W-14	230/400	420	-	-
2528-2W-13	230/400	420	-	-
2528-2W-11	230/400	420	-	-
2528-2W-10	230/400	420	-	-
2528-2W-08	230/400	420	-	-
2831-2W-14	230/400	420	-	-
2831-2W-13	230/400	420	-	-
2831-2W-11	230/400	420	-	-
2831-4W-11	230/400	420	-	-
2831-4D-10	230/400	420	-	-
3135-2W-16	400 △	420	-	-
3135-2W-14	230/400	420	-	-
3135-4W-14	230/400	420	-	-
3135-4W-13	230/400	420	-	-
3135-4W-11	230/400	420	-	-
3540-2W-19	400 △	420	-	-
3540-4W-17	400 △	420	-	-
3540-4W-16	400 △	420	-	-
3540-4W-14	230/400	420	-	-
3540-4W-13	230/400	420	-	-
3540-4W-11	230/400	420	-	-
4045-2W-21	400 △	420	-	-
4045-4W-19	400 △	420	-	-
4045-4W-17	400 △	420	-	-
4045-4W-16	400 △	420	-	-
4045-4W-14	230/400	420	-	-
4045-4W-13	230/400	420	-	-
4550-4W-21	400 △	420	-	-
4550-4W-19	400 △	420	-	-
4550-4W-17	400 △	420	-	-
4550-4W-16	400 △	420	-	-
4550-4W-14	230/400	420	-	-
5056-4W-23	400 △	420	-	-
5056-4W-21	400 △	420	-	-
5056-4W-19	400 △	420	-	-
5056-4W-17	400 △	420	-	-
5056-4W-16	400 △	420	-	-
5056-6W-16	230/400	420	-	-
5663-4W-26	400 △	420	-	-
5663-4W-23	400 △	420	-	-
5663-4W-21	400 △	420	-	-
5663-4W-19	400 △	420	-	-
5663-6W-21	400 △	420	-	-
5663-6W-19	400 △	420	-	-
6371-4W-26	400 △	420	-	-
6371-4W-23	400 △	420	-	-
6371-6W-24	400 △	420	-	-
6371-6W-23	400 △	420	-	-
6371-6W-21	400 △	420	-	-

RLE-Evo RLE-G.-EC

Schaltbilder Zuordnung Ventilatormodule

Ventilatortyp	Motor Schaltbild Nr.	Revisions-schalter ESH 21-	Revisions-schalter Schaltbild Nr.
RLE G0-/G1-/G3-/G6-			
2225-EC-02	626	-	-

RLE-Evo RLE-E.-EC

Schaltbilder Zuordnung Ventilatormodule

Ventilatortyp	Motor Schaltbild Nr.	Revisions-schalter ESH 21-	Revisions-schalter Schaltbild Nr.
RLE E0-/E1-/E3-/E6-			
2528-EC-02	626	-	-
2528-EC-04	625	-	-
2831-EC-04	625	-	-
3135-EC-04	625	-	-
3540-EC-04	625	-	-
3540-EC-06	625	-	-
4045-EC-05	625	-	-
4045-EC-06	625	-	-
4550-EC-06	625	-	-
4550-EC-07	625	-	-
5056-EC-07	625	-	-
5663-EC-07	625	-	-
5663-EC-08	625	-	-

RLM 56

Achtung: Anschlussart auf dem Motortypenschild beachten!

Schaltbilder Zuordnung Ventilatormodule

Ventilator- typ	Anschluss- art	Motor Schaltbild Nr.	Revisions- schalter ESH 21-	Revisions- schalter Schaltbild Nr.
2528-2D/2W-16	400 △	420	-	-
2528-2D/2W-14	230/400	420	-	-
2528-2D/2W-13	230/400	420	-	-
2528-2D/2W-11	230/400	420	-	-
2528-2D/2W-10	230/400	420	-	-
2528-2D/2W-08	230/400	420	-	-
2831-2D/2W-19	400 △	420	-	-
2831-2D/2W-16	400 △	420	-	-
2831-2D/2W-14	230/400	420	-	-
2831-2D/2W-13	230/400	420	-	-
2831-2D/2W-11	230/400	420	-	-
2831-4W-11	230/400	420	-	-
2831-4D/4W-10	230/400	420	-	-
3135-2D/2W-19	400 △	420	-	-
3135-2D/2W-16	400 △	420	-	-
3135-2D/2W-14	230/400	420	-	-
3135-4W-14	230/400	420	-	-
3135-4D/4W-13	230/400	420	-	-
3135-4D/4W-11	230/400	420	-	-
3540-2D/2W-21	400 △	420	-	-
3540-2D/2W-19	400 △	420	-	-
3540-2D/2W-16	400 △	420	-	-
3540-4D/4W-16	400 △	420	-	-
3540-4D/4W-14	230/400	420	-	-
3540-4D/4W-13	230/400	420	-	-
3540-4D/4W-11	230/400	420	-	-
4045-2D/2W-22	400 △	420	-	-
4045-2D/2W-21	400 △	420	-	-
4045-4W-19	400 △	420	-	-
4045-4D/4W-17	400 △	420	-	-
4045-4D/4W-16	400 △	420	-	-
4045-4D/4W-14	230/400	420	-	-
4045-4D/4W-13	230/400	420	-	-
4550-2D/2W-26	400 △	420	-	-
4550-4D/4W-23	400 △	420	-	-
4550-4D/4W-21	400 △	420	-	-
4550-4D/4W-19	400 △	420	-	-
4550-4D/4W-17	400 △	420	-	-
4550-4D/4W-16	400 △	420	-	-
4550-4D/4W-14	230/400	420	-	-
5056-4D/4W-26	400 △	420	-	-
5056-4D/4W-23	400 △	420	-	-
5056-4D/4W-21	400 △	420	-	-
5056-4D/4W-19	400 △	420	-	-
5056-4D/4W-17	400 △	420	-	-
5056-4D/4W-16	400 △	420	-	-
5056-6D/6W-16	230/400	420	-	-
5663-4D/4W-28	400 △	420	-	-
5663-4D/4W-26	400 △	420	-	-
5663-4D/4W-23	400 △	420	-	-
5663-4D/4W-21	400 △	420	-	-
5663-4D/4W-19	400 △	420	-	-
5663-6D/6W-21	400 △	420	-	-
5663-6D/6W-19	400 △	420	-	-
6371-4D/4W-30	400 △	420	-	-
6371-4D/4W-28	400 △	420	-	-
6371-4D/4W-26	400 △	420	-	-
6371-4D/4W-23	400 △	420	-	-
6371-6D/6W-24	400 △	420	-	-
6371-6D/6W-23	400 △	420	-	-
6371-6D/6W-21	400 △	420	-	-
7180-4D/4W-31	400 △	420	-	-
7180-4D/4W-30	400 △	420	-	-
7180-4D/4W-28	400 △	420	-	-
7180-6D/6W-28	400 △	420	-	-
7180-6D/6W-26	400 △	420	-	-
7180-6D/6W-24	400 △	420	-	-
7180-6D/6W-23	400 △	420	-	-

RLM 56

Achtung: Anschlussart auf dem Motortypenschild beachten!

Schaltbilder Zuordnung Ventilatormodule

Ventilator- typ	Anschluss- art	Motor Schaltbild Nr.	Revisions- schalter ESH 21-	Revisions- schalter Schaltbild Nr.
8090-4D/4W-34	400 △	420	-	-
8090-4D/4W-31	400 △	420	-	-
8090-6D/6W-33	400 △	420	-	-
8090-6D/6W-31	400 △	420	-	-
8090-6D/6W-28	400 △	420	-	-
8090-6D/6W-26	400 △	420	-	-
8090-8D/8W-27	400 △	420	-	-
8090-8D/8W-26	400 △	420	-	-
9010-4D/4W-36	400 △	420	-	-
9010-6D/6W-37	400 △	420	-	-
9010-6D/6W-34	400 △	420	-	-
9010-6D/6W-33	400 △	420	-	-
9010-6D/6W-31	400 △	420	-	-
9010-6D/6W-28	400 △	420	-	-
9010-8D/8W-28	400 △	420	-	-
9010-8D/8W-27	400 △	420	-	-
1011-6D/6W-41	400 △	420	-	-
1011-6D/6W-39	400 △	420	-	-
1011-6D/6W-37	400 △	420	-	-
1011-6D/6W-34	400 △	420	-	-
1011-8D/8W-36	400 △	420	-	-
1011-8D/8W-33	400 △	420	-	-
1011-8D/8W-31	400 △	420	-	-

RLM 55

Achtung: Anschlussart auf dem Motortypenschild beachten!

Schaltbilder Zuordnung Ventilatormodule

Ventilator- typ	Anschluss- art	Motor Schaltbild Nr.	Revisions- schalter ESH 21-	Revisions- schalter Schaltbild Nr.
1011-6D/6W-37	400 △	420	-	-
1011-6D/6W-34	400 △	420	-	-
1011-8D/8W-36	400 △	420	-	-
1011-8D/8W-33	400 △	420	-	-
1011-8D/8W-31	400 △	420	-	-
1112-6D/6W-41	400 △	420	-	-
1112-6D/6W-39	400 △	420	-	-
1112-8D/8W-39	400 △	420	-	-
1112-8D/8W-37	400 △	420	-	-
1112-8D/8W-36	400 △	420	-	-
1112-8D/8W-33	400 △	420	-	-
1214-8D/8W-42	400 △	420	-	-
1214-8D/8W-41	400 △	420	-	-
1214-8D/8W-39	400 △	420	-	-

RLM 56-.Y Ex-ATEX II 2G IIB T4

Achtung: Anschlussart auf dem Motortypenschild beachten!

Schaltbilder Zuordnung Ventilatormodule

Ventilator- typ	Anschluss- art	Motor Schaltbild Nr.	Revisions- schalter ESH 21-	Revisions- schalter Schaltbild Nr.
RLM 56-				
2528-2Y-16-2G	400 Δ	481	-	-
2528-2Y-15-2G	230/400	459	-	-
2528-2Y-14-2G	230/400	459	-	-
2528-2Y-11-2G	230/400	459	-	-
2528-2Y-10-2G	230/400	459	-	-
2528-2Y-08-2G	230/400	459	-	-
2831-2Y-19-2G	400 Δ	481	-	-
2831-2Y-16-2G	400 Δ	481	-	-
2831-2Y-15-2G	230/400	459	-	-
2831-2Y-14-2G	230/400	459	-	-
2831-2Y-11-2G	230/400	459	-	-
2831-4Y-10-2G	230/400	459	-	-
3135-2Y-19-2G	400 Δ	481	-	-
3135-2Y-16-2G	400 Δ	481	-	-
3135-2Y-15-2G	230/400	459	-	-
3135-4Y-14-2G	230/400	459	-	-
3135-4Y-11-2G	230/400	459	-	-
3540-2Y-21-2G	400 Δ	481	-	-
3540-2Y-19-2G	400 Δ	481	-	-
3540-2Y-16-2G	400 Δ	481	-	-
3540-4Y-16-2G	400 Δ	481	-	-
3540-4Y-15-2G	230/400	459	-	-
3540-4Y-14-2G	230/400	459	-	-
3540-4Y-11-2G	230/400	459	-	-
4045-2Y-22-2G	400 Δ	481	-	-
4045-2Y-21-2G	400 Δ	481	-	-
4045-4Y-17-2G	400 Δ	481	-	-
4045-4Y-16-2G	400 Δ	481	-	-
4045-4Y-15-2G	230/400	459	-	-
4045-4Y-14-2G	230/400	459	-	-
4550-4Y-23-2G	400 Δ	481	-	-
4550-4Y-21-2G	400 Δ	481	-	-
4550-4Y-19-2G	400 Δ	481	-	-
4550-4Y-17-2G	400 Δ	481	-	-
4550-4Y-16-2G	400 Δ	481	-	-
4550-4Y-15-2G	230/400	459	-	-
5056-4Y-23-2G	400 Δ	481	-	-
5056-4Y-21-2G	400 Δ	481	-	-
5056-4Y-19-2G	400 Δ	481	-	-
5056-4Y-17-2G	400 Δ	481	-	-
5056-4Y-16-2G	400 Δ	481	-	-
5056-6Y-16-2G	230/400	459	-	-
5663-4Y-26-2G	400 Δ	481	-	-
5663-4Y-23-2G	400 Δ	481	-	-
5663-4Y-21-2G	400 Δ	481	-	-
5663-4Y-19-2G	400 Δ	481	-	-
5663-6Y-21-2G	400 Δ	481	-	-
5663-6Y-19-2G	400 Δ	481	-	-
6371-4Y-28-2G	400 Δ	481	-	-
6371-4Y-26-2G	400 Δ	481	-	-
6371-4Y-23-2G	400 Δ	481	-	-
6371-6Y-24-2G	400 Δ	481	-	-
6371-6Y-23-2G	400 Δ	481	-	-
6371-6Y-21-2G	400 Δ	481	-	-
7180-4Y-30-2G	400 Δ	482	-	-
7180-4Y-28-2G	400 Δ	481	-	-
7180-6Y-28-2G	400 Δ	481	-	-
7180-6Y-26-2G	400 Δ	481	-	-
7180-6Y-24-2G	400 Δ	481	-	-
7180-6Y-23-2G	400 Δ	481	-	-
8090-4Y-34-2G	400 Δ	482	-	-
8090-4Y-31-2G	400 Δ	482	-	-
8090-6Y-33-2G	400 Δ	482	-	-
8090-6Y-31-2G	400 Δ	482	-	-
8090-6Y-28-2G	400 Δ	481	-	-
8090-6Y-26-2G	400 Δ	481	-	-
8090-8Y-27-2G	400 Δ	481	-	-
8090-8Y-26-2G	400 Δ	481	-	-

RLM 56-.Y Ex-ATEX II 2G IIB T4

Achtung: Anschlussart auf dem Motortypenschild beachten!

Schaltbilder Zuordnung Ventilatormodule

Ventilator- typ	Anschluss- art	Motor Schaltbild Nr.	Revisions- schalter ESH 21-	Revisions- schalter Schaltbild Nr.
RLM 56-				
9010-6Y-37-2G	400 Δ	482	-	-
9010-6Y-34-2G	400 Δ	482	-	-
9010-6Y-33-2G	400 Δ	482	-	-
9010-6Y-31-2G	400 Δ	482	-	-
9010-6Y-28-2G	400 Δ	481	-	-
9010-8Y-28-2G	400 Δ	481	-	-
9010-8Y-27-2G	400 Δ	481	-	-
1011-6Y-41-2G	400 Δ	482	-	-
1011-6Y-39-2G	400 Δ	482	-	-
1011-6Y-37-2G	400 Δ	482	-	-
1011-6Y-34-2G	400 Δ	482	-	-
1011-8Y-36-2G	400 Δ	482	-	-
1011-8Y-34-2G	400 Δ	482	-	-
1011-8Y-31-2G	400 Δ	482	-	-

RLM 55-.Y Ex-ATEX II 2G IIB T4

Achtung: Anschlussart auf dem Motortypenschild beachten!

Schaltbilder Zuordnung Ventilatormodule

Ventilator- typ	Anschluss- art	Motor Schaltbild Nr.	Revisions- schalter ESH 21-	Revisions- schalter Schaltbild Nr.
RLM 55-				
1112-8Y-39-2G	400 Δ	482	-	-
1112-8Y-37-2G	400 Δ	482	-	-
1112-8Y-36-2G	400 Δ	482	-	-
1112-8Y-34-2G	400 Δ	482	-	-
1214-8Y-41-2G	400 Δ	482	-	-
1214-8Y-39-2G	400 Δ	482	-	-

RLM 16

Schaltbilder Zuordnung Ventilatormodule

Ventilator- typ	Motor Schaltbild Nr.	Revisions- schalter ESH 21-	Revisions- schalter Schaltbild Nr.
RLM 16-			
2020-2D-13	420	-	-
2020-2D-11	420	-	-
2020-2D-10	420	-	-
2020-2D-08	420	-	-
2020-2D-07	420	-	-
2222-2D-16	420	-	-
2222-2D-14	420	-	-
2222-2D-13	420	-	-
2222-2D-11	420	-	-
2222-2D-10	420	-	-
2222-2D-08	420	-	-
2222-2D-07	420	-	-
2525-2D-19	420	-	-
2525-2D-16	420	-	-
2525-2D-14	420	-	-
2525-2D-13	420	-	-
2525-2D-11	420	-	-
2525-2D-10	420	-	-
2525-2D-08	420	-	-

RLE 20

Schaltbilder Zuordnung Motorlaufräder

Ventilatorotyp	Motor Schaltbild Nr.	Revisions-schalter ESH 21-	Revisions-schalter Schaltbild Nr.
RLE 20-0299-2D-50-30	423	21-0030-35	504
RLE 20-0299-4E-50-30	416	21-0030-22	508
RLE 20-0299-6D-50-30	410	21-0030-35	503
RLE 20-0299-6E-50-30	416	21-0030-22	508
RLE 20-0299-MD-50-30	429	21-0030-65	515
RLE 20-0407-4E-50-26	416	21-0030-22	508
RLE 20-0407-6E-50-26	416	21-0030-22	508
RLE 20-0407-MD-50-26	429	21-0030-65	515
RLE 20-0407-ND-50-26	429	21-0030-65	515
RLE 20-0477-4E-50-23	412	21-0030-25	509
RLE 20-0477-6E-50-23	416	21-0030-22	508
RLE 20-0477-MD-50-23	429	21-0030-65	515
RLE 20-0477-ND-50-23	429	21-0030-65	515
RLE 20-0538-6E-50-26	412	21-0030-25	509
RLE 20-0538-MD-50-26	429	21-0030-65	515
RLE 20-0538-ND-50-26	429	21-0030-65	515
RLE 20-0680-ND-50-25	429	21-0030-65	515

RLE 30

Schaltbilder Zuordnung Motorlaufräder

Ventilatorotyp	Motor Schaltbild Nr.	Revisions-schalter ESH 21-	Revisions-schalter Schaltbild Nr.
RLE 30-0288-2D-50-37	423	21-0030-35	504
RLE 30-0288-4E-50-37	416	21-0030-22	508
RLE 30-0288-6D-50-37	410	21-0030-35	503
RLE 30-0288-6E-50-37	416	21-0030-22	508
RLE 30-0288-MD-50-37	429	21-0030-65	515
RLE 30-0323-4E-50-37	416	21-0030-22	508
RLE 30-0323-6D-50-37	410	21-0030-35	503
RLE 30-0323-6E-50-37	416	21-0030-22	508
RLE 30-0323-MD-50-37	429	21-0030-65	515
RLE 30-0363-4E-50-37	416	21-0030-22	508
RLE 30-0363-6E-50-37	416	21-0030-22	508
RLE 30-0363-MD-50-37	429	21-0030-65	515
RLE 30-0363-ND-50-37	429	21-0030-65	515
RLE 30-0406-4E-50-37	412	21-0030-25	509
RLE 30-0406-6E-50-37	416	21-0030-22	508
RLE 30-0406-MD-50-37	429	21-0030-65	515
RLE 30-0406-ND-50-37	429	21-0030-65	515
RLE 30-0455-4E-50-28	412	21-0030-25	509
RLE 30-0455-4E-50-37	412	21-0030-25	509
RLE 30-0455-6E-50-28	416	21-0030-22	508
RLE 30-0455-6E-50-37	416	21-0030-22	508
RLE 30-0455-MD-50-28	429	21-0030-65	515
RLE 30-0455-MD-50-37	429	21-0030-65	515
RLE 30-0455-ND-50-28	429	21-0030-65	515
RLE 30-0455-ND-50-37	429	21-0030-65	515
RLE 30-0510-4E-50-37	412	21-0030-25	509
RLE 30-0510-6E-50-37	412	21-0030-25	509
RLE 30-0510-MD-50-37	429	21-0030-65	515
RLE 30-0510-ND-50-37	429	21-0030-65	515
RLE 30-0570-6E-50-37	412	21-0030-25	509
RLE 30-0570-ND-50-37	429	21-0030-65	515
RLE 30-0640-ND-50-37	429	21-0030-65	515

RLE 50

Schaltbilder Zuordnung Motorlaufräder

Ventilatorotyp	Motor Schaltbild Nr.	Revisions-schalter ESH 21-	Revisions-schalter Schaltbild Nr.
RLE 50-0288-2D-50-28	423	21-0030-35	504
RLE 50-0323-2D-50-28	423	21-0030-35	504
RLE 50-0570-MD-50-18	429	21-0030-65	515
RLE 50-0570-ND-50-18	429	21-0030-65	515
RLE 50-0570-4E-50-18	412	21-0030-25	509
RLE 50-0570-6E-50-18	412	21-0030-25	509

RLE 90

Schaltbilder Zuordnung Motorlaufräder

Ventilatorotyp	Motor Schaltbild Nr.	Revisions-schalter ESH 21-	Revisions-schalter Schaltbild Nr.
RLE 90-0241-2D-50-28	423	21-0030-35	504
RLE 90-0480-MD-50-34	429	21-0030-65	515
RLE 90-0480-ND-50-34	429	21-0030-65	515
RLE 90-0480-4E-50-34	412	21-0030-25	509
RLE 90-0480-6E-51-34	416	21-0030-22	508
RLE 90-0570-MD-50-25	454	21-0030-35	570

RLE 20-/30-/50-EC

Schaltbilder Zuordnung Motorlaufräder

Ventilatorotyp	Motor Schaltbild Nr.	Revisions-schalter ESH 21-	Revisions-schalter Schaltbild Nr.
RLE 30-0288-EC-00-37	-	21-0030-22	621
RLE 30-0323-EC-00-37	-	21-0030-22	621
RLE 30-0363-EC-00-37	-	21-0030-22	621
RLE 30-0406-EC-00-37	-	21-0030-22	621
RLE 30-0406-EC-01-37	-	21-0030-22	621
RLE 30-0455-EC-00-28	-	21-0030-22	621
RLE 30-0455-EC-01-28	-	21-0030-22	621
RLE 30-0455-EC-01-37	-	21-0030-22	621
RLE 30-0510-EC-01-37	-	21-0030-22	621
RLE 30-0570-EC-01-37	-	21-0030-22	621
RLE 20-0299-EC-00-30	-	21-0030-22	621
RLE 20-0407-EC-00-26	-	21-0030-22	621
RLE 20-0407-EC-01-26	-	21-0030-22	621
RLE 20-0477-EC-00-23	-	21-0030-22	621
RLE 20-0477-EC-01-23	-	21-0030-22	621
RLE 20-0538-EC-01-26	-	21-0030-22	621
RLE 50-0570-EC-01-18	-	21-0030-22	621

RLA 34

Schaltbilder Zuordnung Ventilatormodule

Ventilatorotyp	Motor Schaltbild Nr.	Revisions-schalter ESH 21-	Revisions-schalter Schaltbild Nr.
RLA 34-2531-4E	416	0030-22	508
2531-4D-S	458		
3535-4E	416	0030-22	508
3540-4E	412	0030-25	509
3545-4E	412	0030-25	509
4550-4E	412	0030-25	509
4550-ND	429	0030-65	515
4556-MD	443	0030-65	516
5663-HD	441	0030-65	514

AWA | AQA | ATA 11-

AWA | AQA | ATA 61-
ARA 61-/62-

Schaltbilder Zuordnung Axialventilatoren

Ventilortyp	Motor Schaltbild Nr.	Revisions- schalter ESH 21-	Revisions- schalter Schaltbild Nr.
11-0200-2E	411	–	–
11-0200-4S	414	–	–
11-0250-2E	411	–	–
11-0250-4S	414	–	–
11-0300-2E	411	–	–
11-0300-4E	411	–	–

Schaltbilder Zuordnung Axialventilatoren

Ventilortyp	Motor Schaltbild Nr.	Revisions- schalter ESH 21-	Revisions- schalter Schaltbild Nr.
AWA / AQA / ATA 61- ARA 61-/62-			
0315-4D	410	–	–
0315-6D	410	–	–
0315-4E	416	–	–
0315-6E	416	–	–
0355-4D	410	–	–
0355-6D	410	–	–
0355-4E	416	–	–
0355-6E	416	–	–
0400-4D	410	–	–
0400-6D	410	–	–
0400-4E	416	–	–
0400-6E	416	–	–
0450-4D	410	–	–
0450-6D	410	–	–
0450-4E	416	–	–
0450-6E	416	–	–
0500-4D	410	–	–
0500-6D	410	–	–
0500-4E	412	–	–
0500-6E	416	–	–
0560-4D	410	–	–
0560-6D	410	–	–
0560-4E	412	–	–
0560-6E	412	–	–
0630-4D	410	–	–
0630-6D	410	–	–
0630-6E	412	–	–

Dreieckschaltung (Δ)

Delta-connection

Branchement triangle

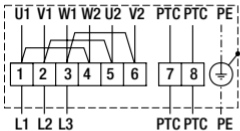

Sternschaltung (Y)

Star-connection

Branchement étoile

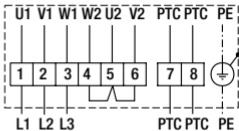

Δ Frequenzumrichter-Betrieb 400 V, Eckfrequenz 87 Hz

Δ Frequency converter operation 400 V,
cut off frequency 87 Hz

Δ Fonctionnement variateur de fréquence
400 V, fréquence de coupure 87 Hz

Y Netzbetrieb

Y mains operation at

Y alimentation réseau

400 V, 50 Hz / 460 V, 60 Hz

 = grün/gelb, green/yellow, vert/jaune

U1 = braun, brown, marron

V1 = blau, blue, bleu

W1 = schwarz, black, noir

W2 = orange

U2 = rot, red, rouge

V2 = grau, grey, gris

PTC = weiß, white, blanc

Dreieckschaltung (Δ)

Delta-connection

Branchement triangle

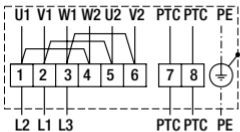

Sternschaltung (Y)

Star-connection

Branchement étoile

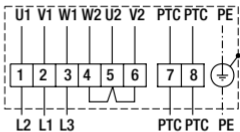

Δ Frequenzumrichter-Betrieb 400 V, Eckfrequenz 87 Hz

Δ Frequency converter operation 400 V,
cut off frequency 87 Hz

Δ Fonctionnement variateur de fréquence
400 V, fréquence de coupure 87 Hz

Y Netzbetrieb

Y mains operation at

Y alimentation réseau

400 V, 50 Hz / 460 V, 60 Hz

 = grün/gelb, green/yellow, vert/jaune

U1 = braun, brown, marron

V1 = blau, blue, bleu

W1 = schwarz, black, noir

W2 = orange

U2 = rot, red, rouge

V2 = grau, grey, gris

PTC = weiß, white, blanc

Eintouriger Drehstrom

Three-phase A.C.

Stern - Schaltung (Y)
Star - connection

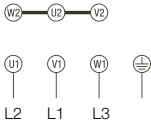

Dreieck - Schaltung (Δ)
Delta - connection

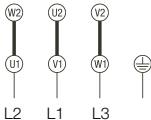

Drehrichtungsänderung durch Vertauschen
von 2 Netzphasen
Reversible rotation by interchanging phases

⊕ = grün/gelb,
green/yellow,
U1 = braun, brown
V1 = blau, blue (grau, grey)
W1 = schwarz, black

Eintouriger Drehstrommotor

Three-phase A.C. motor

Moteur triphasé à 1 vitesse

Stern - Schaltung (Y)

Star - connection

Branchement étoile

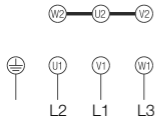

Drehrichtungsänderung durch
Vertauschen von 2 Netzphasen

Reversible rotation by
interchanging phases

Changement du sens de rotation
par inversion de 2 phases

Dreieck - Schaltung ()

Delta - connection

Branchement triangle

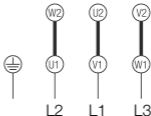

⊕ = grün/gelb, green/yellow, vert/jaune

U1 = braun, brown, marron

V1 = blau, blue, bleu

W1 = schwarz, black, noir

W2 = weiß, white, blanc

U2 = rot, red, rouge

V2 = grau, grey, gris

Drehstrommotor mit 2 getrennten Wicklungen

Three-phase A.C. motor with two separate windings

Moteur triphasé à 2 bobinage indépendants

niedere Drehzahl (Y)
low speed
petite vitesse

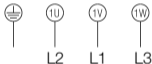
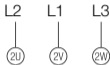

Drehrichtungsänderung durch
Vertauschen von 2 Netzphasen

Reversible rotation by
interchanging phases

Changement du sens de rotation
par inversion de 2 phases

⊕ = grün/gelb, green/yellow, vert/jaune

1U = braun, brown, marron

1V = blau, blue, bleu

1W = schwarz, black, noir

2U = rot, red, rouge

2V = grau, grey, gris

2W = weiß, white, blanc

Drehstrommotor, polumschaltbar nach Dahlander

Three-phase DAHLANDER type tapping (pole changeable A.C. motor)

niedere Drehzahl (Y)
low speed

2U 2V 2W

L2 L1 L3

2U 2V 2W

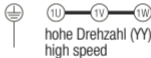
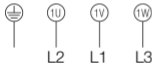

Drehrichtungsänderung durch
Vertauschen von 2 Netzphasen
Reversible rotation by
interchanging phases

⊕ = grün/gelb, green/yellow
1U = braun, brown
1V = blau, blue
1W = schwarz, black
2U = rot, red
2V = grau, grey
2W = orange (weiss, white)

Eintouriger Drehstrom-Ex-Motor

Three-phase A.C. Ex-motor

Moteur anti-déflagrant triphasé à 1 vitesse

Stern - Schaltung (Y)

Star - connection

Branchement étoile

Brücke W2-U2-V2 bauseits

Bridge connection on site

Pont électrique sur site



L2

L1

L3

Drehrichtungsänderung durch
Vertauschen von 2 Netzphasen

Reversible rotation by
interchanging phases

Changement du sens de rotation
par inversion de 2 phases

⊕ = grün/gelb, green/yellow, vert/jaune

U1 = braun, brown, marron

V1 = blau, blue, bleu

W1 = schwarz, black, noir

W2 = orange

U2 = rot, red, rouge

V2 = grau, grey, gris

Drehstrommotor mit 2 getrennten Wicklungen und Thermokontakt (T)

Three-phase A.C. motor with two separate windings and thermal cut out (T)

Moteur triphasé à 2 bobinage indépendants et thermocontact de bobinage (T)

niedere Drehzahl (Y)

low speed

petite vitesse

Steuerstromkreis

Control circuit

Circuit de commande

hohe Drehzahl (Y)

high speed

grande vitesse

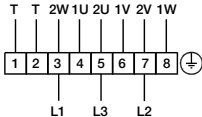
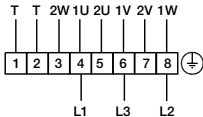

Drehrichtungsänderung durch Vertauschen von 2 Netzphasen

Reversible rotation by interchanging phases

Changement du sens de rotation par inversion de 2 phases

⊕ = grün/gelb, green/yellow, vert/jaune

U1 = braun, brown, marron

V1 = blau, blue, bleu

W1 = schwarz, black, noir

W2 = orange

U2 = rot, red, rouge

V2 = grau, grey, gris

T = weiß, white, blanc

Drehstrommotor, polumschaltbar nach Dahlander mit Thermokontakt (T)

Three-phase DAHLANDER type tapping (pole changeable) with thermal cut out (T)

Moteur triphasé à pôle commutables type DAHLANDER, et thermocontact de bobinage (T)

niedere Drehzahl (Y)
low speed
petite vitesse

Steuerstromkreis
Control circuit
Circuit de commande

hohe Drehzahl (YY)
high speed
grande vitesse

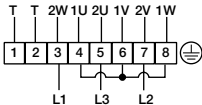
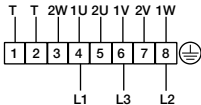

Drehrichtungsänderung durch Vertauschen
von 2 Netzphasen

Reversible rotation by interchanging phases

Changement du sens de rotation par
inversion de 2 phases

⊕ = grün/gelb, green/yellow, vert/jaune

U1 = braun, brown, marron

V1 = blau, blue, bleu

W1 = schwarz, black, noir

W2 = orange

U2 = rot, red, rouge

V2 = grau, grey, gris

T = weiß, white, blanc

Drehstrommotor, polumschaltbar nach Dahlander mit Thermokontakt (T)
Three-phase DAHLANDER type tapping (pole changeable) with thermal cut out (T)
Moteur triphasé à pôle commutables type DAHLANDER, et thermocontact de bobinage (T)

niedere Drehzahl (Y)
 low speed
 petite vitesse

Steuerstromkreis
 Control circuit
 Circuit de commande

hohe Drehzahl (YY)
 high speed
 grande vitesse

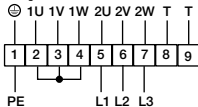
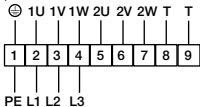

Drehrichtungsänderung durch Vertauschen
 von 2 Netzphasen
 Reversible rotation by interchanging phases
 Changement du sens de rotation par
 inversion de 2 phases

⊕ = grün/gelb, green/yellow, vert/jaune
U1 = braun, brown, marron
V1 = blau, blue, bleu
W1 = schwarz, black, noir
U2 = rot, red, rouge
V2 = grau, grey, gris
W2 = orange
T = weiß, white, blanc

Stouriger Drehstrommotor mit Thermokontakt (T)

Three-phase A.C. motor with thermal cut out (T)

Moteur triphasé à 1 vitesse avec thermocontact de bobinage (T)

Stern - Schaltung (Y)

Star - connection

Branchement étoile

Steuerstromkreis

Control circuit

Circuit de

Dreieck - Schaltung (Δ)

Delta - connection

Branchement triangle

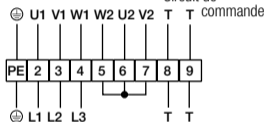

Drehrichtungsänderung durch
Vertauschen von 2 Netzphasen

Reversible rotation by
interchanging phases

Changement du sens de rotation
par inversion de 2 phases

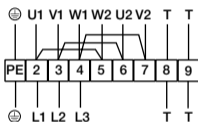

⊕ = grün/gelb, green/yellow, vert/jaune

U1 = braun, brown, marron

V1 = blau, blue, bleu

W1 = schwarz, black, noir

W2 = orange

U2 = rot, red, rouge

V2 = grau, grey, gris

T = weiß, white, blanc

Einphasen-Wechselstrommotor mit Betriebskondensator und Thermokontakt in Reihe mit der Motorwicklung
single-phase A.C. motor with capacitor and thermal cut out in sequence with winding

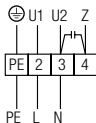

Drehrichtungsänderung nicht möglich
Reversible rotation not possible

U1, L = blau, blue
U2, N = schwarz, black
Z = braun, brown
⊖, PE = grün/gelb, green/yellow

Einphasen-Wechselstrom mit Betriebskondensator und Thermokontakt (T)

Single-phase A.C. motor with capacitor and thermal cut out (T)

Moteur monophasé à condensateur permanent et thermocontact de bobinage (T)

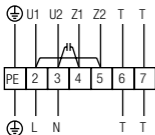

Netz
Mains
Secteur

Steuerstromkreis
Control circuit
Circuit de commande

- U1** = braun, brown, marron
- U2** = blau, blue, bleu
- Z1** = schwarz, black, noir
- Z2** = orange
- T** = weiß, white, blanc
-  = grün/gelb,
green/yellow,
vert/jaune

Einphasen-Wechselstrom mit Betriebskondensator und Thermokontakt (T)

Single-phase A.C. motor with capacitor and thermal cut out (T)

Moteur monophasé à condensateur permanent et thermocontact de bobinage (T)

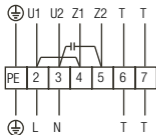

Netz
Mains
Secteur

Steuerstromkreis
Control circuit
Circuit de commande

U1 = braun, brown, marron

U2 = blau, blue, bleu

Z1 = schwarz, black, noir

Z2 = orange

T = weiß, white, blanc

 = grün/gelb,
green/yellow,
vert/jaune

Einphasen-Wechselstrommotor
Single-phase A.C. motor
Moteur monophasé

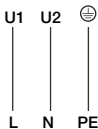

Drehrichtungsänderung
nicht möglich

Reversible rotation not possible

L'inversion du sens de rotation
n'est pas possible

U1, L = blau, blue, bleu
U2, N = schwarz, black, noir
⊕, PE = grün/gelb,
green/yellow,
vert/jaune

Einphasen-Wechselstrommotor mit Betriebskondensator, Drehzahl umschaltbar, mit Thermokontakt (T)

single-phase A.C. motor capacitor, two speeds, thermal cut out (T)

Moteur monophasé à condensateur permanent à deux vitesses commutables et thermocontact de bobinage (T)

niedere Drehzahl
low speed
petite vitesse

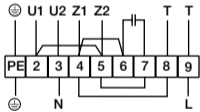

Netz / Mains / secteur

hohe Drehzahl
high speed
grande vitesse

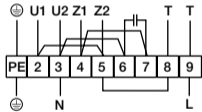

- ⊕ = grün/gelb, green/yellow, vert/jaune
- U1** = braun, brown, marron
- U2** = blau, blue, bleu
- Z1** = schwarz, black, noir
- Z2** = orange
- T** = weiß, white, blanc

Einphasen-Wechselstrommotor mit Betriebskondensator und Thermokontakt (T)
single-phase A.C. motor capacitor and thermal cout out (T)
Moteur monophasé à condensateur permanent et thermocontact de bobinage (T)

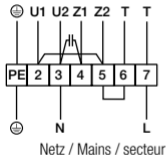

- ⊕ = grün/gelb, green/yellow, vert/jaune
- U1** = braun, brown, marron
- U2** = blau, blue, bleu
- Z1** = schwarz, black, noir
- Z2** = orange
- T** = weiß, white, blanc

Drehstrommotor mit 2 getrennten Wicklungen und Thermokontakt (T)

Three-phase A.C. motor with two separate windings and thermal cut out (T)

Moteur triphasé à 2 bobinage indépendants et thermocontact de bobinage (T)

niedere Drehzahl

low speed

petite vitesse

T T 1U 1V 1W 2U 2V 2W

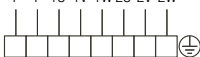

L2 L1 L3

Netz/Mains/Secteur

Drehrichtungsänderung durch Vertauschen von 2 Netzphasen

Reversible rotation by interchanging phases

Changement du sens de rotation par inversion de 2 phases

hohe Drehzahl

high speed

grande vitesse

Thermokontakt thermal cut out thermocontact T T 1U 1V 1W 2U 2V 2W



L2 L1 L3

⊕ = grün/gelb, green/yellow, vert/jaune

1U = braun, brown, marron

1V = blau, blue, bleu

1W = schwarz, black, noir

2U = rot, red, rouge

2V = grau, grey, gris

2W = orange

T = weiß, white, blanc

Drehstrommotor, polumschaltbar nach Dahlander mit Thermokontakt (T)
Three-phase DAHLANDER type tapping (pole changeable) with thermal cut out (T)
Moteur triphasé à pôle commutables type DAHLANDER, et thermocontact de bobinage (T)

niedere Drehzahl (Y)
 low speed
 petite vitesse

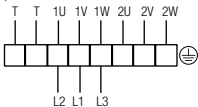

Steuerstromkreis
 Control circuit
 Circuit de commande

hohe Drehzahl (YY)
 high speed
 grande vitesse

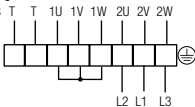

Drehrichtungsänderung durch Vertauschen
 von 2 Netzphasen
 Reversible rotation by interchanging phases
 Changement du sens de rotation par
 inversion de 2 phases

⊕ = grün/gelb, green/yellow, vert/jaune
 1U = braun, brown, marron
 1V = blau, blue, bleu
 1W = schwarz, black, noir
 2U = rot, red, rouge
 2V = grau, grey, gris
 2W = orange
 T = weiß, white, blanc

01-11-01

Eintouriger Drehstrommotor mit Thermokontakt (T)

Three-phase A.C. motor with thermal contact (T)

Moteur triphasé à 1 vitesse avec thermocontact de bobinage (T)

Stern - Schaltung (Y)

Star - connection

Branchement étoile

Steuerstromkreis

Control circuit

Circuit de

Dreieck - Schaltung (Δ)

Delta - connection

Branchement triangle

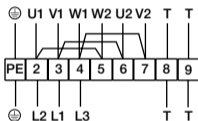
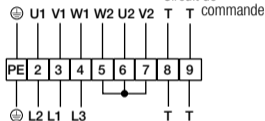

Drehrichtungsänderung durch
Vertauschen von 2 Netzphasen

Reversible rotation by
interchanging phases

Changement du sens de rotation
par inversion de 2 phases

⊕ = grün/gelb, green/yellow, vert/jaune

U1 = braun, brown, marron

V1 = blau, blue, bleu

W1 = schwarz, black, noir

W2 = orange

U2 = rot, red, rouge

V2 = grau, grey, gris

T = weiß, white, blanc

Eintouriger Drehstrommotor, optional mit PTC

Three-phase A.C. motor, optional w/PTC Thermistor

Moteur triphasé à 1 vitesse, PTC Sonde en option

Stern - Schaltung (Y)

Star - connection

Branchement étoile

Dreieck - Schaltung (Δ)

Delta - connection

Branchement triangle

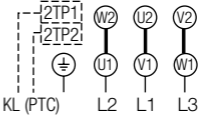
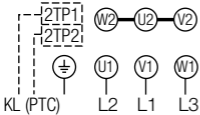

Drehstrommotor mit 2 getrennten Wicklungen
Three-phase A.C. motor with two separate windings
Moteur triphasé à 2 bobinage indépendants

niedere Drehzahl
low speed
petite vitesse

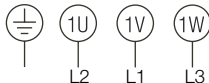
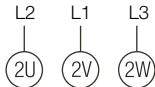

hohe Drehzahl
high speed
grande vitesse

Drehstrommotor, polumschaltbar nach Dahlander

Three-phase DAHLANDER type tapping (pole changeable A.C. motor)

Moteur triphasé à pôle commutables type DAHLANDER

niedere Drehzahl (Y)
low speed
petite vitesse

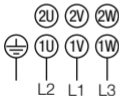

hohe Drehzahl (YY)
high speed
grande vitesse

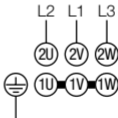

Eintouriger Drehstrommotor, mit Thermokontakt (T)

Three-phase A.C. motor, with thermal cut out (T)

Moteur triphasé à 1 vitesse avec thermocontact de bobinage (T)

Stern-Schaltung (Y)

Star-connection

Branchement étoile

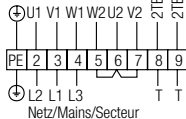

Steuerstromkreis

Control circuit

Circuit de command

Drehrichtungsänderung durch
Vertauschen von 2 Netzphasen

Reversible rotation by
interchanging phases

Changement du sens de rotation
par inversion de 2 phases

⊕ = grün/gelb, green/yellow, vert/jaune

U1 = weiß, white, blanc

V1 = schwarz, black, noir

W1 = braun, brown, marron

W2 = blau, blue, bleu

U2 = grau, grey, gris

V2 = rot, red, rouge

2TB1 = orange

2TB2 = orange

Eintouriger Drehstrommotor, optional mit PTC
Three-phase A.C. motor, optional w/PTC Thermistor
Moteur triphasé à 1 vitesse, PTC Sonde en option

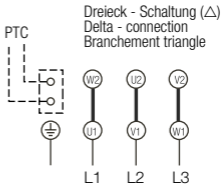
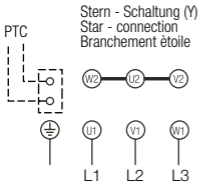

Eintouriger Drehstrommotor mit Thermokontakt (T)

Three-phase A.C. motor with thermal cut out (T)

Moteur triphasé à 1 vitesse avec thermocontact de bobinage (T)

Stern-Schaltung (Y)

Star-connection

Branchement étoile

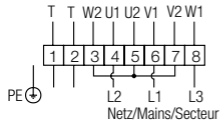

Drehrichtungsänderung durch
Vertauschen von 2 Netzphasen

Reversible rotation by
interchanging phases

Changement du sens de rotation
par inversion de 2 phases

Dreieck-Schaltung (Δ)

Delta-connection

Branchement triangle



⊕ = grün/gelb, green/yellow, vert/jaune

U1 = braun, brown, marron

V1 = blau, blue, bleu

W1 = schwarz, black, noir

U2 = rot, red, rouge

V2 = grau, grey, gris

W2 = orange

T = weiß, white, blanc

Eintouriger Drehstrommotor mit Thermokontakt (T)

Three-phase A.C. motor with thermal cut out (T)

Moteur triphasé à 1 vitesse avec thermocontact de bobinage (T)

Stern-Schaltung (Y)

Star-connection

Branchement étoile

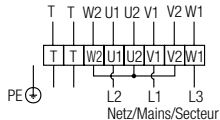

Dreieck-Schaltung (Δ)

Delta-connection

Branchement triangle

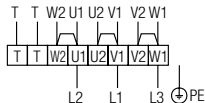

Drehrichtungsänderung durch
Vertauschen von 2 Netzphasen

Reversible rotation by
interchanging phases

Changement du sens de rotation
par inversion de 2 phases

Drehstrommotor in Dreieck-Schaltung mit Thermokontakt (T) und Betriebskondensator am Einphasen-Netz

Three-phase A.C. motor, delta winding, thermal cut out (T) an capacitor for single-phase supply

Moteur triphasé connecté en triangle avec thermocontact de bobinage (T) et condensateur permanent pour fonctionnement en monophasé

Thermokontakt
thermal cut out
thermocontact

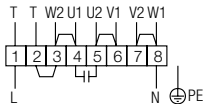

Netz
Mains
Secteur

Kondensator
Capacitor
Condensateur

⊕ = grün/gelb, green/yellow, vert/jaune
U1 = braun, brown, marron
V1 = blau, blue, bleu
W1 = schwarz, black, noir
U2 = rot, red, rouge
V2 = grau, grey, gris
W2 = orange
T = weiß, white, blanc

Drehstrommotor, drehzahlumschaltbar, Thermokontakt (T)

Three-phase A.C. motor, two speeds, thermal cut out (T)

Moteur triphasé, deux vitesses commutables et thermocontact de bobinage (T)

niedere Drehzahl (Y)

low speed

petite vitesse

hohe Drehzahl (Δ)

high speed

grande vitesse

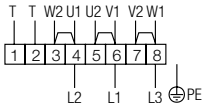
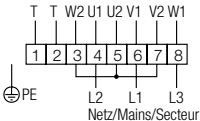

Drehrichtungsänderung durch
Vertauschen von 2 Netzphasen

Reversible rotation by
interchanging phases

Changement du sens de rotation
par inversion de 2 phases

\oplus = grün/gelb, green/yellow, vert/jaune

U1 = braun, brown, marron

V1 = blau, blue, bleu

W1 = schwarz, black, noir

U2 = rot, red, rouge

V2 = grau, grey, gris

W2 = orange

T = weiß, white, blanc

Drehstrommotor, drehzahlumschaltbar, mit Thermokontakt (T)

Three-phase A.C. motor, two speeds, permanently rated, with thermal cut out (T)

Moteur triphasé, deux vitesses commutables et thermocontact de bobinage (T)

niedere Drehzahl (Y)

low speed

petite vitesse

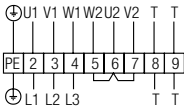

Netz/Mains/Secteur

Drehrichtungsänderung durch
Vertauschen von 2 Netzphasen

Reversible rotation by
interchanging phases

Changement du sens de rotation
par inversion de 2 phases

hohe Drehzahl (Δ)

high speed

grande vitesse

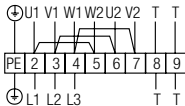

⊕ = grün/gelb, green/yellow, vert/jaune

U1 = braun, brown, marron

V1 = blau, blue, bleu

W1 = schwarz, black, noir

U2 = rot, red, rouge

V2 = grau, grey, gris

W2 = orange

T = weiß, white, blanc

Eintouriger Drehstrom mit Thermokontakt

Three-phase A.C. motor with thermal cut out

Moteur triphasé à 1 vitesse avec thermocontact de bobinage

Stern - Schaltung (Y)

Star - connection

Branchement étoile

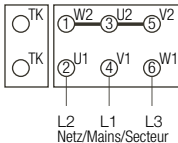

Thermokontakt
thermal cut out
thermocontact

Dreieck - Schaltung (Δ)

Delta - connection

Branchement triangle

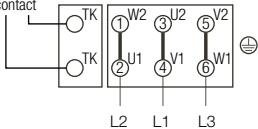

Drehrichtungsänderung durch Vertauschen
von 2 Netzphasen

Reversible rotation by interchanging phases

Changement du sens de rotation par
inversion de 2 phases

Drehstrommotor, mit Thermokontakt (T)

Three-phase A.C. motor, with thermal cut out (T)

Moteur triphasé avec thermocontact de bobinage (T)

Stern-Schaltung (Y)

Star-connection

Branchement étoile

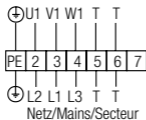

Steuerstromkreis

Control circuit

Circuit de command

Drehrichtungsänderung durch
Vertauschen von 2 Netzphasen

Reversible rotation by
interchanging phases

Changement du sens de rotation
par inversion de 2 phases

⊕ = grün/gelb, green/yellow, vert/jaune

U1 = braun, brown, marron

V1 = blau, blue, bleu

W1 = schwarz, black, noir

T = weiß, white, blanc
(grau, grey, gris)

Drehstrommotor, Y/ Δ -Schaltung, mit Thermokontakt (T)

Three-phase A.C. motor, Y/ Δ -connection, with thermal cut out (T)

Moteur triphasé, brachement Y/ Δ et thermocontact de bobinage (T)

Stern-Schaltung (Y)

star connection

branchement étoile

Dreieck-Schaltung (Δ)

delta-connection

branchement triangle

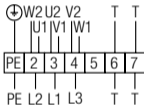
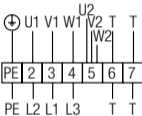

Drehrichtungsänderung durch
Vertauschen von 2 Netzphasen

Reversible rotation by
interchanging phases

Changement du sens de rotation
par inversion de 2 phases

\oplus = grün/gelb, green/yellow, vert/jaune

U1 = braun, brown, marron

V1 = blau, blue, bleu

W1 = schwarz, black, noir

U2 = rot, red, rouge

V2 = grau, grey, gris

W2 = orange

T = weiß, white, blanc

Drehstrommotor, mit Thermokontakt (T)

Three-phase A.C. motor, with thermal cut out (T)

Moteur triphasé avec thermocontact de bobinage (T)

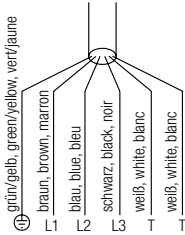

Drehstrommotor
Three-phase A.C. motor
Moteur triphasé

Stern-Schaltung (Y)
Star-connection
Branchement étoile

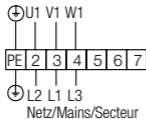

Steuerstromkreis
Control circuit
Circuit de command

Drehrichtungsänderung durch
Vertauschen von 2 Netzphasen

Reversible rotation by
interchanging phases

Changement du sens de rotation
par inversion de 2 phases

⊕ = grün/gelb, green/yellow, vert/jaune
U1 = braun, brown, marron
V1 = blau, blue, bleu
W1 = schwarz, black, noir

Drehstrommotor mit 2 getrennten Wicklungen

Three-phase A.C. motor with two separate windings

Moteur triphasé à 2 bobinage indépendants

niedere Drehzahl

low speed

petite vitesse

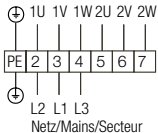

Drehrichtungsänderung durch Vertauschen von 2 Netzphasen

Reversible rotation by interchanging phases

Changement du sens de rotation par inversion de 2 phases

hohe Drehzahl

high speed

grande vitesse

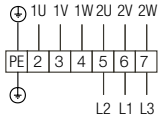

⊕ = grün/gelb, green/yellow, vert/jaune

1U = braun, brown, marron

1V = blau, blue, bleu

1W = schwarz, black, noir

2U = rot, red, rouge

2V = grau, grey, gris

2W = weiss, white, blanc

Drehstrommotor, polumschaltbar nach Dahlander Three-phase DAHLANDER type tapping (pole changeable)

niedere Drehzahl (Y)
low speed

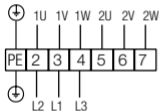

hohe Drehzahl (YY)
high speed

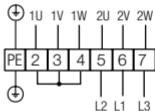

Drehrichtungsänderung durch Vertauschen
von 2 Netzphasen

Reversible rotation by interchanging phases

⊕ = grün/gelb, green/yellow
1U = braun, brown
1V = blau, blue
1W = schwarz, black
2U = rot, red
2V = grau, grey
2W = orange (weiss, white)

Eintouriger Drehstrommotor mit Thermokontakt (T)

Three-phase A.C. motor with thermal cut out (T)

Moteur triphasé à 1 vitesse avec thermocontact de bobinage (T)

Stern - Schaltung (Y)

Star - connection

Branchement étoile

Steuerstromkreis

Control circuit

Circuit de

Dreieck - Schaltung (Δ)

Delta - connection

Branchement triangle

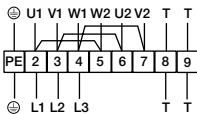
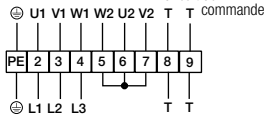

Drehrichtungsänderung durch
Vertauschen von 2 Netzphasen

Reversible rotation by
interchanging phases

Changement du sens de rotation
par inversion de 2 phases

⊕ = grün/gelb, green/yellow, vert/jaune

U1 = braun, brown, marron

V1 = blau, blue, bleu

W1 = schwarz, black, noir

W2 = orange

U2 = rot, red, rouge

V2 = grau, grey, gris

T = weiß, white, blanc

T = violett, violet

Eintouriger Drehstrommotor mit Thermokontakt (T)

Three-phase A.C. motor with thermal cut out (T)

Moteur triphasé à 1 vitesse avec thermocontact de bobinage (T)

Stern - Schaltung (Y)

Star - connection

Branchement étoile

Steuerstromkreis

Control circuit

Circuit de

Dreieck - Schaltung (Δ)

Delta - connection

Branchement triangle

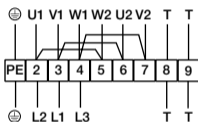
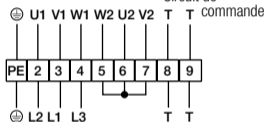

Drehrichtungsänderung durch
Vertauschen von 2 Netzphasen

Reversible rotation by
interchanging phases

Changement du sens de rotation
par inversion de 2 phases

⊕ = grün/gelb, green/yellow, vert/jaune

U1 = braun, brown, marron

V1 = blau, blue, bleu

W1 = schwarz, black, noir

W2 = orange

U2 = rot, red, rouge

V2 = grau, grey, gris

T = weiß, white, blanc

Drehstrommotor, polumschaltbar nach Dahlander mit Thermokontakt (T)
Three-phase DAHLANDER type tapping (pole changeable) with thermal cut out (T)
Moteur triphasé à pôle commutables type DAHLANDER, et thermocontact de bobinage (T)

niedere Drehzahl (Y)
 low speed
 petite vitesse

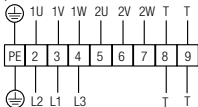

Drehrichtungsänderung durch Vertauschen
 von 2 Netzphasen
 Reversible rotation by interchanging phases
 Changement du sens de rotation par
 inversion de 2 phases

hohe Drehzahl (YY)
 high speed
 grande vitesse

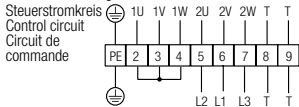

⊕ = grün/gelb, green/yellow, vert/jaune
 1U = braun, brown, marron
 1V = blau, blue, bleu
 1W = schwarz, black, noir
 2U = rot, red, rouge
 2V = grau, grey, gris
 2W = orange
 T = weiß, white, blanc

Drehstrommotor, Δ -Schaltung, mit Thermokontakt (T)

Three-phase A.C. motor, Δ -connection, with thermal cut out (T)

Moteur triphasé, brachement Δ et thermocontact de bobinage (T)

Dreieck-Schaltung (Δ)

delta-connection

brachement triangle

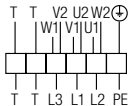

Drehrichtungsänderung durch
Vertauschen von 2 Netzphasen

Reversible rotation by
interchanging phases

Changement du sens de rotation
par inversion de 2 phases

\oplus = grün/gelb, green/yellow, vert/jaune

U1 = braun, brown, marron

V1 = blau, blue, bleu

W1 = schwarz, black, noir

U2 = rot, red, rouge

V2 = grau, grey, gris

W2 = orange

T = weiß, white, blanc

Drehstrommotor, drehzahlumschaltbar, mit Thermokontakt (T)

Three-phase A.C. motor, two speeds, permanently rated, with thermal cut out (T)

Moteur triphasé, deux vitesses commutables et thermocontact de bobinage (T)

niedere Drehzahl (Y)

low speed

petite vitesse

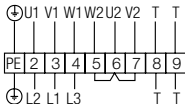

Netz/Mains/Secteur

Drehrichtungsänderung durch
Vertauschen von 2 Netzphasen

Reversible rotation by
interchanging phases

Changement du sens de rotation
par inversion de 2 phases

hohe Drehzahl ()

high speed

grande vitesse

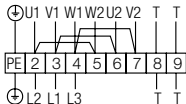

⊕ = grün/gelb, green/yellow, vert/jaune

U1 = braun, brown, marron

V1 = blau, blue, bleu

W1 = schwarz, black, noir

U2 = rot, red, rouge

V2 = grau, grey, gris

W2 = orange

T = weiß, white, blanc

Eintouriger Drehstrom-Ex-Motor mit PTC

Three-phase A.C. Ex-motor with PTC Thermistor

Stern - Schaltung (Y) 400 V
Star - connection

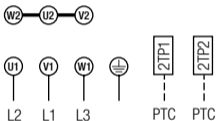

Drehrichtungsänderung durch
Vertauschen von 2 Netzphasen
Reversible rotation by
interchanging phases

W2-U2-V2 intern in Stern verschaltet,
PTC Anschluss nur über Auslösegerät
mit ATEX Zulassung.

Star connection W2-U2-V2 internal,
PTC connection only over release unit
with ATEX permission.

-  = grün/gelb, green/yellow
- U1** = braun, brown
- V1** = blau, blue (grau, grey)
- W1** = schwarz, black
- 2TP1** = weiß, white
- 2TP2** = weiß, white

Eintouriger Drehstrom Ex-Motor mit PTC

Three-phase A.C. Ex-motor with PTC Thermistor

Dreieck - Schaltung (Δ) 400 V
Delta - connection

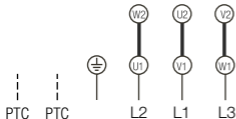

PTC Anschluss nur über Auslösegerät
mit ATEX Zulassung.

PTC connection only over release unit
with ATEX permission.

-  = grün/gelb, green/yellow
- U1** = braun, brown
- V1** = blau, blue
- W1** = schwarz, black
- W2** = orange
- U2** = rot, red
- V2** = grau, grey
- PTC** = weiss, white

Eintouriger Drehstrommotor, Y/ Δ Anlauf
Three-phase A.C. motor, Y/ Δ started

Option RDM 31/32:

KL (PTC) --- 2TP1
KL (PTC) --- 2TP2

Stern - Schaltung (Y)
Star - connection

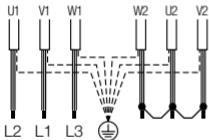

Dreieck - Schaltung (Δ)
Delta - connection

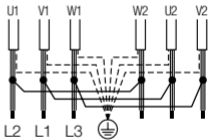

Drehrichtungsänderung durch
Vertauschen von 2 Netzphasen

Reversible rotation by
interchanging phases

\oplus = grün/gelb, green/yellow

13-09-11

Drehstrommotor, Δ -Schaltung, mit Thermokontakt (T)

Three-phase A.C. motor, Δ -connection, with thermal cut out (T)

Moteur triphasé, brachement Δ et thermocontact de bobinage (T)

Dreieck-Schaltung (Δ) 400 V

delta-connection

brachement triangle

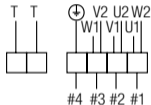

Drehrichtungsänderung durch
Vertauschen von 2 Netzphasen

Reversible rotation by
interchanging phases

Changement du sens de rotation
par inversion de 2 phases

\oplus = grün/gelb, green/yellow, vert/jaune

U1 = braun, brown, marron

V1 = blau, blue, bleu

W1 = schwarz, black, noir

U2 = rot, red, rouge

V2 = grau, grey, gris

W2 = orange

T = weiß, white, blanc

Eintouriger Drehstrommotor
Three-phase A.C. motor
Moteur triphasé à 1 vitesse

Stern - Schaltung (Y)
Star - connection
Branchement étoile

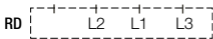
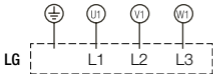
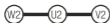

Dreieck - Schaltung (Δ)
Delta - connection
Branchement triangle

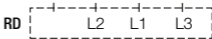
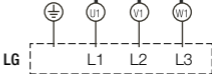

Eintouriger Drehstrom Three-phase A.C. Moteur triphasé à 1 vitesse

Stern - Schaltung (Y)
Star - connection
Branchement étoile

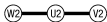

L2 L1 L3

Dreieck - Schaltung (Δ)
Delta - connection
Branchement triangle

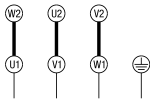

L2 L1 L3

Drehrichtungsänderung durch Vertauschen
von 2 Netzphasen

Reversible rotation by interchanging phases

Changement du sens de rotation par
inversion de 2 phases

\oplus = grün/gelb, green/yellow, vert/jaune

U1 = [1]

V1 = [2]

W1 = [3]

Drehstrommotor mit 2 getrennten Wicklungen

Three-phase A.C. motor with two separate windings

Option RDM 31/32:

KL (PTC) --- [2TP1]

KL (PTC) --- [2TP2]

niedere Drehzahl
low speed

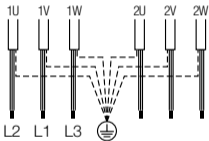

hohe Drehzahl
high speed

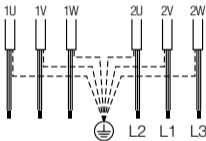

Drehrichtungsänderung durch
Vertauschen von 2 Netzphasen

Reversible rotation by
interchanging phases

⊕ = grün/gelb, green/yellow

13-09-11

450

Drehstrommotor, polumschaltbar nach Dahlander

Three-phase DAHLANDER type tapping

(pole changeable A.C. motor)

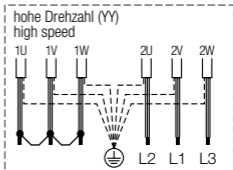
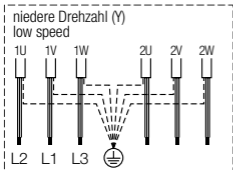

⊕ = grün/gelb, green/yellow, vert/jaune

Drehrichtungsänderung durch Vertauschen von 2 Netzphasen

Reversible rotation by interchanging phases

Changement du sens de rotation par inversion de 2 phases

Option RDM 31/32:

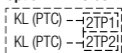

21-05-12

Umringelter Drehstrommotor mit Thermokontakt (T)
Three-phase A.C. motor with thermal cut out (T)
Moteur triphasé à 1 vitesse avec thermocontact de bobinage (T)

Stern - Schaltung (Y) 400 V
Star - connection
Branchement étoile

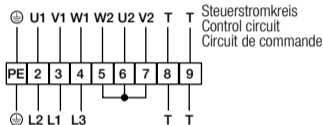

Drehrichtungsänderung durch
Vertauschen von 2 Netzphasen

Reversible rotation by
interchanging phases

Changement du sens de rotation
par inversion de 2 phases

⊕ = grün/gelb, green/yellow, vert/jaune
U1-V1-W1 = braun, brown, marron
W2-U2-V2 = blau, blue, bleu
T = weiß, white, blanc

Drehstrommotor, Δ -Schaltung, mit Thermokontakt (T)

Three-phase A.C. motor, Δ -connection, with thermal cut out (T)

Moteur triphasé, brachement Δ et thermocontact de bobinage (T)

Dreieck-Schaltung (Δ) 400 V

delta-connection

brachement triangle

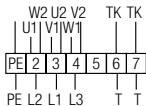

Drehrichtungsänderung durch
Vertauschen von 2 Netzphasen

Reversible rotation by
interchanging phases

Changement du sens de rotation
par inversion de 2 phases

\oplus = grün/gelb, green/yellow, vert/jaune

U1 = braun, brown, marron

V1 = blau, blue, bleu

W1 = schwarz, black, noir

U2 = rot, red, rouge

V2 = grau, grey, gris

W2 = orange

T = weiß, white, blanc

Eintouriger Drehstrommotor mit Thermokontakt (T)
Three-phase A.C. motor with thermal cout out (T)
Moteur triphasé à 1 vitesse avec thermocontact de bobinage (T)

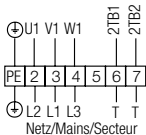

- ⊕ = grün/gelb, green/yellow, vert/jaune
U1 = braun, brown, marron
V1 = blau, blue, bleu
W1 = schwarz, black, noir
2TB1 = weiss, white, blanc
2TB2 = weiss, white, blanc (grau, grey, gris)

Drehrichtungsänderung durch Vertauschen von 2 Netzphasen
Reversible rotation by interchanging phases
Changement du sens de rotation par inversion de 2 phases

Eintouriger Drehstrommotor mit Thermokontakt (T)
Three-phase A.C. motor with thermal cut out (T)
Moteur triphasé à 1 vitesse avec thermocontact de bobinage (T)

Dreieck - Schaltung (Δ) 400 V
Delta - connection
Branchement triangle

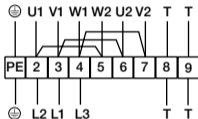

Drehrichtungsänderung durch
Vertauschen von 2 Netzphasen

Reversible rotation by
interchanging phases

Changement du sens de rotation
par inversion de 2 phases

\oplus = grün/gelb, green/yellow, vert/jaune
U1 = braun, brown, marron
V1 = blau, blue, bleu
W1 = schwarz, black, noir
U2 = rot, red, rouge
V2 = grau, grey, gris
W2 = orange
T = weiß, white, blanc

Drehstrommotor, polumschaltbar nach Dahlander mit Thermokontakt (T)
Three-phase DAHLANDER type tapping (pole changeable) with thermal cut out (T)
Moteur triphasé à pôle commutables type DAHLANDER, et thermocontact de bobinage (T)

niedere Drehzahl (Y)
 low speed
 petite vitesse

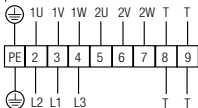

Drehrichtungsänderung durch Vertauschen von 2 Netzphasen
 Reversible rotation by interchanging phases
 Changement du sens de rotation par inversion de 2 phases

hohe Drehzahl (YY)
 high speed
 grande vitesse

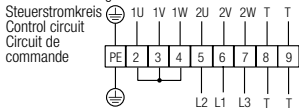

⊕ = grün/gelb, green/yellow, vert/jaune
 1U = braun, brown, marron
 1V = blau, blue, bleu
 1W = schwarz, black, noir
 2U = rot, red, rouge
 2V = grau, grey, gris
 2W = orange
 T = weiß, white, blanc

Drehstrommotor, polumschaltbar, 2 getrennte Wicklungen mit Thermokontakt (T)
Three-phase motor, pole changeable with two separate windings and thermal cut out (T)
Moteur triphasé à pôle commutables, 2 bobinage indépendants et thermocontact de bobinage (T)

niedere Drehzahl (Y)
 low speed
 petite vitesse

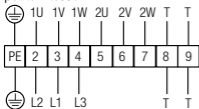

Steuerstromkreis
 Control circuit
 Circuit de commande

hohe Drehzahl (Y)
 high speed
 grande vitesse

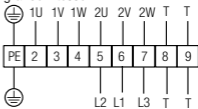

Drehrichtungsänderung durch Vertauschen
 von 2 Netzphasen

Reversible rotation by interchanging phases

Changement du sens de rotation par
 inversion de 2 phases

- ⊕ = grün/gelb, green/yellow, vert/jaune
- 1U** = braun, brown, marron
- 1V** = blau, blue, bleu
- 1W** = schwarz, black, noir
- 2U** = rot, red, rouge
- 2V** = grau, grey, gris
- 2W** = orange
- T** = weiß, white, blanc

Eintouriger Drehstrommotor mit Thermokontakt (T) One speed three-phase motor with thermal cut out (T)

Stern-Schaltung (Y)
Star Connection

Steuerstromkreis
Control circuit

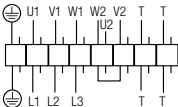

⊕ = grün/gelb, green/yellow
U1 = braun, brown,
V1 = blau, blue
W1 = schwarz, black
U2 = rot, red
V2 = grau, grey
W2 = orange
T = weiß, white

Eintouriger Drehstrommotor, Ex, mit PTC
Three-phase A.C. motor, Ex, with PTC Thermistor
Moteur triphasé à 1 vitesse, Ex, PTC Sonde

Stern - Schaltung (Y)
Star - connection
Branchement étoile

zur Steuerung
to Control
pour Contrôler

Dreieck - Schaltung (Δ)
Delta - connection
Branchement triangle

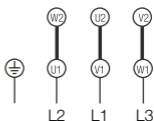
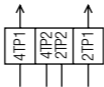
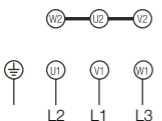

Drehstrommotor mit 2 getrennten Wicklungen

Three-phase A.C. motor with two separate windings

Moteur triphasé à 2 bobinage indépendants

niedere Drehzahl (Y)
low speed
petite vitesse

(2U) (2V) (2W)



(1U)

(1V)

(1W)

LG

L1

L2

L3

RD

L2

L1

L3

LG

L1

L2

L3

RD

L2

L1

L3

(2U)

(2V)

(2W)

(1U)

(1V)

(1W)

hohe Drehzahl (Y)
high speed
grande vitesse

Drehstrommotor, polumschaltbar nach Dahlander

Three-phase DAHLANDER type tapping (pole changeable A.C. motor)

Moteur triphasé à pôle commutables type DAHLANDER

niedere Drehzahl (Y)
low speed
petite vitesse

(2U) (2V) (2W)

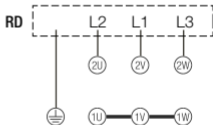
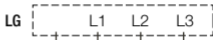
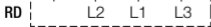
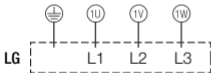

hohe Drehzahl (YY)
high speed
grande vitesse

09-03-04

Einphasen-Wechselstrommotor mit Betriebskondensator, Thermokontakt (T) und Phasenanschnittssteuergerät
single-phase A.C. motor capacitor, thermal cut out (T) and wave phase control circuitry

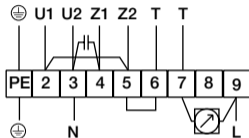

Netz / Mains

⊕ = grün/gelb, green/yellow, vert/jaune

U1 = braun, brown, marron

U2 = blau, blue, bleu

Z1 = schwarz, black, noir

Z2 = orange

T = weiß, white, blanc

Drehstrommotor, mit Thermokontakt (T)

Three-phase A.C. motor, with thermal cut out (T)

Moteur triphasé avec thermocontact de bobinage (T)

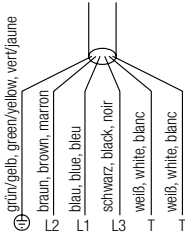

Drehstrommotor, Δ -Schaltung, mit Thermokontakt (T)

Three-phase A.C. motor, Δ -connection, with thermal cut out (T)

Moteur triphasé, brachement Δ et thermocontact de bobinage (T)

Dreieck-Schaltung (Δ)

delta-connection

brachement triangle

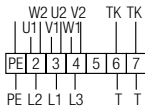

Drehrichtungsänderung durch
Vertauschen von 2 Netzphasen

Reversible rotation by
interchanging phases

Changement du sens de rotation
par inversion de 2 phases

\oplus = grün/gelb, green/yellow, vert/jaune

U1 = braun, brown, marron

V1 = blau, blue, bleu

W1 = schwarz, black, noir

U2 = rot, red, rouge

V2 = grau, grey, gris

W2 = orange

T = weiß, white, blanc

Drehstrommotor, Y-Schaltung, mit Thermokontakt (T)

Three-phase A.C. motor, Y-connection, with thermal cut out (T)

Moteur triphasé, brachement Y et thermocontact de bobinage (T)

Stern-Schaltung (Y)

star connection

branchement étoile

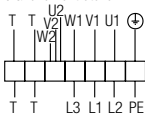

Drehrichtungsänderung durch
Vertauschen von 2 Netzphasen

Reversible rotation by
interchanging phases

Changement du sens de rotation
par inversion de 2 phases

⊕ = grün/gelb, green/yellow, vert/jaune

U1 = braun, brown, marron

V1 = blau, blue, bleu

W1 = schwarz, black, noir

U2 = rot, red, rouge

V2 = grau, grey, gris

W2 = orange

T = weiß, white, blanc

Steckerbelegung
Drehstrommotor
mit Sternpunkt
Plug connection
three-phase motor
with neutral point

Buchsenteil | Socket

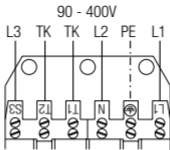

⊕ = grün/gelb,
green/yellow

L1 = braun, brown

L2 = blau, blue

L3 = schwarz, black

U1 = braun, brown

V1 = blau, blue

W1 = schwarz, black

TK = weiß, white

Steckerteil | Plug

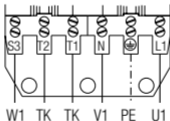

Motor



orange

rot, red

grau, grey

M 3~

12-07-04

466

Einphasen-Wechselstrom mit Betriebskondensator, Thermokontakt (T)
Single-phase AC-motor with capacitor, thermal cut out (T)

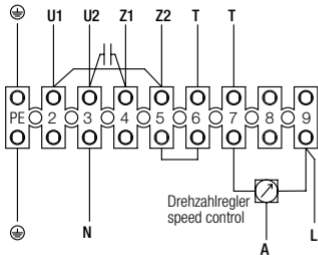

- ⊕ = grün/gelb, green/yellow
- U1 = braun, brown
- U2 = blau, blue
- Z1 = schwarz, black
- Z2 = orange
- T = weiß, white
- A = rot, red

A Offenes Kabelende für zusätzlichen Anschluss
A open cable end for auxiliary load

Einphasiger AC - FFU mit UL-Zulassung
Single-phase AC - FFU with UL-Permission

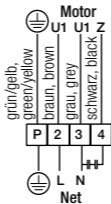

FFU mit UL-Zulassung
FFU with UL-Permission



Drehstrommotor, Δ -Schaltung, mit Thermokontakt (T)

Three-phase A.C. motor, Δ -connection, with thermal cut out (T)

Moteur triphasé, brachement Δ et thermocontact de bobinage (T)

Dreieck-Schaltung (Δ) 400 V

delta-connection

brachement triangle

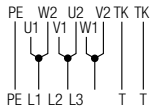

Drehrichtungsänderung durch
Vertauschen von 2 Netzphasen

Reversible rotation by
interchanging phases

Changement du sens de rotation
par inversion de 2 phases

\oplus = grün/gelb, green/yellow, vert/jaune

U1 = braun, brown, marron

V1 = blau, blue, bleu

W1 = schwarz, black, noir

U2 = rot, red, rouge

V2 = grau, grey, gris

W2 = orange

TK = weiß, white, blanc

Drehstrommotor, 400 V, 50 Hz

Three-phase A.C. motor, 400 V, 50 Hz

Moteur triphasé 400 V, 50 Hz

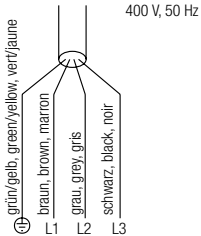

Eintouriger Drehstrommotor

Three-phase A.C. motor

Moteur triphasé à 1 vitesse

Stern - Schaltung (Y)

Star - connection

Branchement étoile

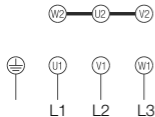

Dreieck - Schaltung (Δ)

Delta - connection

Branchement triangle

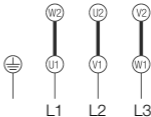

Drehrichtungsänderung durch
Vertauschen von 2 Netzphasen

Reversible rotation by
interchanging phases

Changement du sens de rotation
par inversion de 2 phases

\oplus = grün/gelb, green/yellow, vert/jaune

U1 = schwarz-U1, black-U1, noir-U1

V1 = schwarz-V1, black-V1, noir-V1

W1 = schwarz-W1, black-W1, noir-W1

W2 = schwarz-W2, black-W2, noir-W2

U2 = schwarz-U2, black-U2, noir-U2

V2 = schwarz-V2, black-V2, noir-V2

472

Drehstrommotor, polumschaltbar nach Dahlander

Three-phase DAHLANDER type tapping (pole changeable A.C. motor)

niedere Drehzahl (Y)
low speed

2U 2V 2W

L1 L2 L3
2U 2V 2W

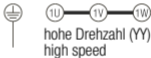
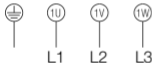

Drehrichtungsänderung durch
Vertauschen von 2 Netzphasen

Reversible rotation by
interchanging phases

⊕ = grün/gelb, green/yellow, vert/jaune

1U = schwarz-U1, black-U1, noir-U1

1V = schwarz-V1, black-V1, noir-V1

1W = schwarz-W1, black-W1, noir-W1

2W = schwarz-W2, black-W2, noir-W2

2U = schwarz-U2, black-U2, noir-U2

2V = schwarz-V2, black-V2, noir-V2

473

Eintouriger Drehstrom

Three-phase A.C.

Stern - Schaltung (Y)
Star - connection

Dreieck - Schaltung (Δ)
Delta - connection

KL (PTC) -- [2TP1]
KL (PTC) -- [2TP2]

KL (PTC) -- [2TP1]
KL (PTC) -- [2TP2]

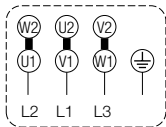
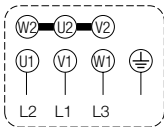

Drehrichtungsänderung durch Vertauschen von 2 Netzphasen
Reversible rotation by interchanging phases

Drehstrommotor mit 2 getrennten Wicklungen
Three-phase A.C. motor with two separate windings
Moteur triphasé à 2 bobinage indépendants

niedere Drehzahl KL (PTC) — [2TP1]
 low speed KL (PTC) — [2TP2]
 petite vitesse

hohe Drehzahl KL (PTC) — [2TP1]
 high speed KL (PTC) — [2TP2]
 grande vitesse

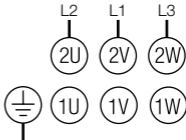
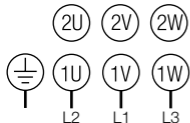

Drehrichtungsänderung durch Vertauschen von 2 Netzphasen
 Reversible rotation by interchanging phases
 Changement du sens de rotation par inversion de 2 phases

Drehstrommotor, polumschaltbar nach Dahlander

Three-phase DAHLANDER type tapping (pole changeable A.C. motor)

niedere Drehzahl (Y)
low speed

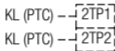
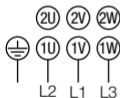

hohe Drehzahl (YY)
high speed

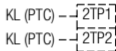
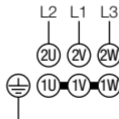

Drehrichtungsänderung durch
Vertauschen von 2 Netzphasen

Reversible rotation by
interchanging phases

Drehstrommotor

Three-phase A.C. motor

Stern-Schaltung (Y)

Star-connection

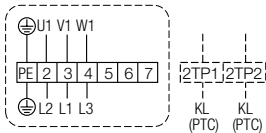

Netz/Mains

⊕ = grün/gelb, green/yellow

U1 = braun, brown

V1 = blau, blue (grau, grey)

W1 = schwarz, black

Steuerstromkreis separat

Control circuit separately

Drehrichtungsänderung durch Vertauschen von 2 Netzphasen

Reversible rotation by interchanging phases

Drehstrommotor mit 2 getrennten Wicklungen

Three-phase A.C. motor with two separate windings

niedere Drehzahl
low speed

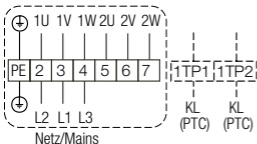

hohe Drehzahl
high speed

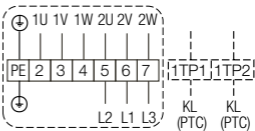

Steuerstromkreis separat
Control circuit separately

Drehrichtungsänderung durch Vertauschen
von 2 Netzphasen

Reversible rotation by interchanging phases

⊕ = grün/gelb, green/yellow, vert/jaune

1U = braun, brown, marron

1V = blau, blue, bleu

1W = schwarz, black, noir

2U = rot, red, rouge

2V = grau, grey, gris

2W = orange (weiss, white, blanc) **478**

Drehstrommotor, polumschaltbar nach Dahlander

Three-phase DAHLANDER type tapping (pole changeable)

niedere Drehzahl (Y)
low speed

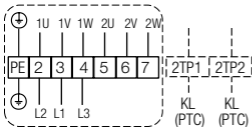

Steuerstromkreis separat
Control circuit separately

Drehrichtungsänderung durch Vertauschen
von 2 Netzphasen
Reversible rotation by interchanging phases

hohe Drehzahl (YY)
high speed

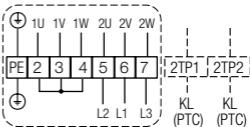

⊕ = grün/gelb, green/yellow
1U = braun, brown
1V = blau, blue
1W = schwarz, black
2U = rot, red
2V = grau, grey
2W = orange (weiss, white)

Drehstrommotor, mit PTC
Three-phase A.C. motor, with PTC Thermistor
Moteur triphasé avec PTC Sonde

Stern-Schaltung (Y)
 Star-connection
 Branchement étoile

Netz
 Mains
 Secteur

Drehrichtungsänderung durch
 Vertauschen von 2 Netzphasen
 Reversible rotation by
 interchanging phases
 Changement du sens de rotation
 par inversion de 2 phases

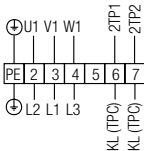

Steuerstromkreis
 Control circuit
 Circuit de command

- ⊕ = grün/gelb, green/yellow, vert/jaune
- U1** = braun, brown, marron
- V1** = blau, blue, bleu
- W1** = schwarz, black, noir
- PTC** = weiß, white, blanc
(grau, grey, gris)

Eintouriger Drehstrommotor, Ex, mit PTC
Three-phase A.C. motor, Ex, with PTC Thermistor
Moteur triphasé à 1 vitesse, Ex, PTC Sonde

Dreieck - Schaltung (Δ)
Delta - connection
Branchement triangle

zur Steuerung
to Control
pour Contrôler

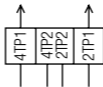
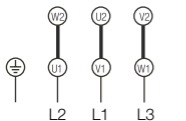

Eintouriger Drehstrommotor, Ex, mit PTC
Three-phase A.C. motor, Ex, with PTC Thermistor
Moteur triphasé à 1 vitesse, Ex, PTC Sonde

Dreieck - Schaltung (Δ)
Delta - connection
Branchement triangle

zur Steuerung
to Control
pour Contrôler

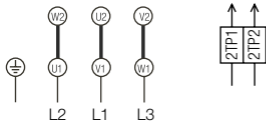

Eintouriger Drehstrommotor
Three-phase A.C. motor
Moteur triphasé à 1 vitesse

Stern - Schaltung (Y)
 Star - connection
 Branchement étoile

Dreieck - Schaltung (Δ)
 Delta - connection
 Branchement triangle

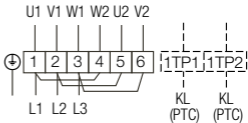
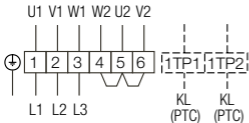

Drehrichtungsänderung durch
 Vertauschen von 2 Netzphasen
 Reversible rotation by
 interchanging phases
 Changement du sens de rotation
 par inversion de 2 phases

\oplus = grün/gelb, green/yellow, vert/jaune
U1 = braun, brown, marron
V1 = blau, blue, bleu
W1 = schwarz, black, noir
W2 = orange (weiss, white, blanc)
U2 = rot, red, rouge
V2 = grau, grey, gris

Drehstrommotor, polumschaltbar nach Dahlander

Three-phase DAHLANDER type tapping (pole changeable A.C. motor)

niedere Drehzahl (Y)
low speed

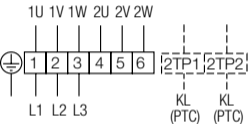

hohe Drehzahl (YY)
high speed

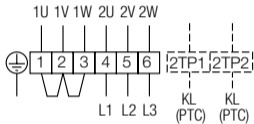

Drehrichtungsänderung durch
Vertauschen von 2 Netzphasen

Reversible rotation by
interchanging phases

⊕ = grün/gelb, green/yellow, vert/jaune
1U = braun, brown, marron
1V = blau, blue, bleu
1W = schwarz, black, noir
2U = rot, red, rouge
2V = grau, grey, gris
2W = orange (weiss, white, blanc)

Eintouriger Drehstrommotor mit Kaltleiter (PTC)

Three-phase A.C. motor with PTC Thermistor

Moteur triphasé à 1 vitesse avec PTC Sonde

Stern - Schaltung (Y) 400 V

Star - connection

Branchement étoile

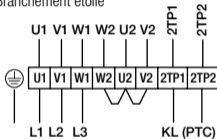

Drehrichtungsänderung durch
Vertauschen von 2 Netzphasen

Reversible rotation by
interchanging phases

Changement du sens de rotation
par inversion de 2 phases

Dreieck - Schaltung (Δ) 230 V

Delta - connection

Branchement triangle

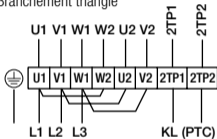

\oplus = grün/gelb, green/yellow, vert/jaune

U1 = braun, brown, marron

V1 = blau, blue, bleu

W1 = schwarz, black, noir

W2 = orange

U2 = rot, red, rouge

V2 = grau, grey, gris

Eintouriger Drehstrommotor

Three-phase A.C. motor

Moteur triphasé à 1 vitesse

Stern - Schaltung (Y)

Star - connection

Branchement étoile

Dreieck - Schaltung (Δ)

Delta - connection

Branchement triangle

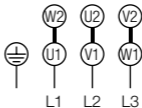
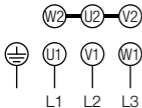

Drehrichtungsänderung durch
Vertauschen von 2 Netzphasen

Reversible rotation by
interchanging phases

Changement du sens de rotation
par inversion de 2 phases

\oplus = grün/gelb, green/yellow, vert/jaune

U1 = blau, blue, bleu

V1 = gelb, yellow, jaune

W1 = braun, brown, marron

W2 = weiß, white, blanc

U2 = rot, red, rouge

V2 = schwarz, black, noir

Drehstrommotor, polumschaltbar nach Dahlander (bzw. PAM)

Three-phase DAHLANDER type tapping (pole changeable A.C. motor) (resp. PAM)

niedere Drehzahl (Y)
low speed

2U 2V 2W

L1 L2 L3

2U 2V 2W

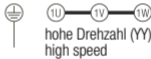
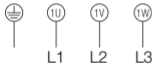

Drehrichtungsänderung durch
Vertauschen von 2 Netzphasen
Reversible rotation by
interchanging phases

⊕ = grün/gelb, green/yellow, vert/jaune
1U = weiß, white, blanc
1V = braun, brown, marron
1W = blau, blue, bleu
2U = gelb, yellow, jaune
2V = rot, red, rouge
2W = schwarz, black, noir

Eintouriger Drehstrommotor

Three-phase A.C. motor

Stern - Schaltung (Y)
Star - connection

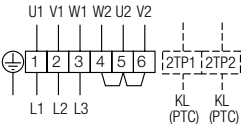

Dreieck - Schaltung (Δ)
Delta - connection

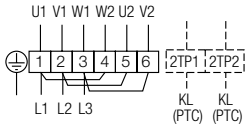

Drehrichtungsänderung
durch Vertauschen von
2 Netzphasen
Reversible rotation by
interchanging phases

\oplus = grün/gelb, green/yellow

U1 = braun, brown

V1 = blau, blue

W1 = schwarz, black

W2 = orange

U2 = rot, red

V2 = grau, grey

2TP1 = weiss, white

2TP2 = pink, rosa

Drehstrommotor, polumschaltbar nach Dahlander (bzw. PAM Schaltung) Three-phase DAHLANDER (PAM) type tapping (pole changeable A.C. motor)

niedere Drehzahl (Y)
low speed

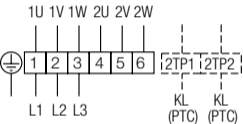

hohe Drehzahl (YY)
high speed

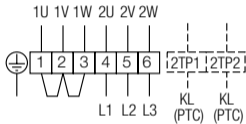

Drehrichtungsänderung
durch Vertauschen von
2 Netzphasen
Reversible rotation by
interchanging phases

⊕ = grün/gelb, green/yellow

1U = braun, brown

1V = blau, blue

1W = schwarz, black

2U = rot, red

2V = grau, grey

2W = orange

2TP1 = weiss, white

2TP2 = pink, rosa

Eintouriger Drehstrommotor

Three-phase A.C. motor

Stern - Schaltung (Y)
Star - connection

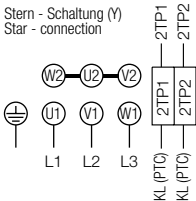

Dreieck - Schaltung (Δ)
Delta - connection

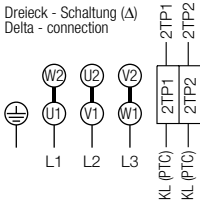

Drehrichtungsänderung
durch Vertauschen von
2 Netzphasen

Reversible rotation by
interchanging phases

= grün/gelb, green/yellow

U1 = braun, brown

V1 = blau, blue

W1 = schwarz, black

W2 = weiss, white

U2 = rot, red

V2 = grau, grey

2TP1 = weiss, white

2TP2 = schwarz, black

Permanentmagneterregter Synchronmotor

Permanent magnet synchronous motor

Stern - Schaltung (Y - 400V)
Star - connection

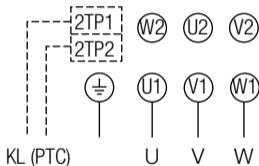

W2-U2-V2 intern
in stern verschaltet

Kein Netzbetrieb!

Nur mit geeignetem
Umrichter betreiben

Star connection
W2-U2-V2 internal

No mains operation!

Operation only with
suitable inverter

Permanentmagneterregter Synchronmotor

Permanent magnet synchronous motor

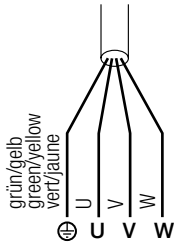

Motor intern
verschaltet

Kein Netzbetrieb!

Nur mit geeignetem
Umrichter betreiben

motor connection
internal

No mains operation!

Operation only with
suitable inverter

Revisionsschalter/Isolator ESH 21-0075-35

für Drehstrommotoren, 1 Drehzahl, Δ -Schaltung, mit Thermokontakt
 for three-phase A.C., single speed, Δ -Connection, with thermal contacts

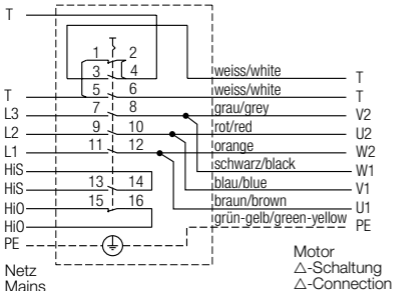

Revisionsschalter/Isolator ESH 21-0030-35 / ESH 21-0075-35
 für Drehstrommotoren, 1 Drehzahl, mit Thermokontakt, Δ -Schaltung
 for three-phase A.C., single speed, Δ -Connection, with thermal contacts

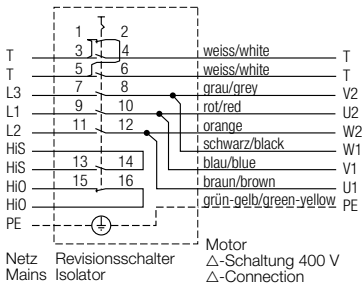

Bitte die Δ -Schaltung
 innerhalb des
 Klemmkasten realisieren!
 Please realise
 Δ -Connection inside box!

Revisionsschalter/Isolator ESH 21-0030-35

für Drehstrommotoren, 1 Drehzahl, mit Thermokontakt, Y/ Δ -Schaltung
 for three-phase A.C., single speed Y/ Δ , with thermal contacts

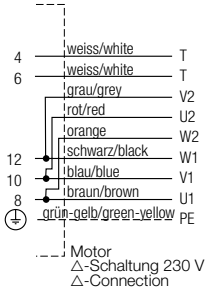
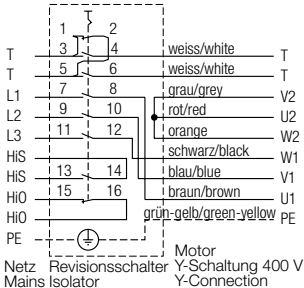

Revisionsschalter/Isolator ESH 21-0030-35

für Drehstrommotoren, 1 Drehzahl, Y-Schaltung, mit Thermokontakt
 for three-phase A.C., single speed, Y-Connection, with thermal contacts

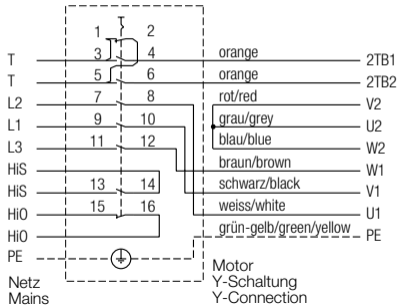

Revisionsschalter/Isolator ESH 21-0030-35

für Drehstrommotoren, 1 Drehzahl, mit Thermokontakt, Y/ Δ -Schaltung
 for three-phase A.C., single speed, Y/ Δ -Connection, with thermal contacts

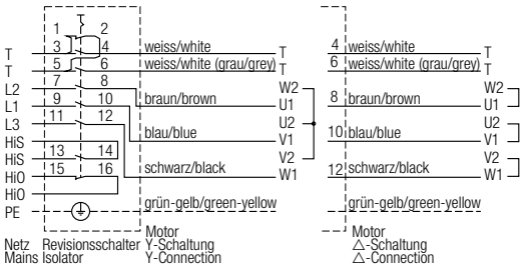

Revisionsschalter/Isolator ESH 21-0030-65 / ESH 21-0075-65
 für Drehstrommotoren, 2 Drehzahlen, Y/ Δ -Schaltung, mit Thermokontakten
 for three-phase A.C., 2 speeds, Y/ Δ -Connection, with thermal contacts

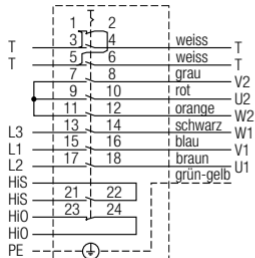

Netz Revisionsschalter Motor Y
 Mains Isolator
 niedrigere Drehzahl/low speed

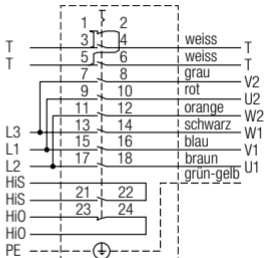

Netz Revisionsschalter Motor Δ
 Mains Isolator
 hohe Drehzahl/high speed

Revisionsschalter/Isolator ESH 21-0030-22

für Einphasen-Wechselstrommotoren, mit Betriebskondensator,
Thermokontakte in der Motorwicklung verschaltet
for single-phase A.C., with capacitor and thermal contacts
in series with the motor winding

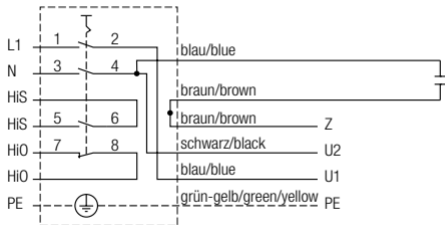

Netz Mains
Revisionsschalter Isolator

Motor

Betriebskondensator
Capacitor

Revisionsschalter/Isolator ESH 21-0030-22

für Einphasen-Wechselstrommotoren, mit Betriebskondensator,
Thermkontakte und Motorwicklung in Reihe verschaltet
for single-phase A.C., with capacitor,
thermal contacts in series with the motor winding

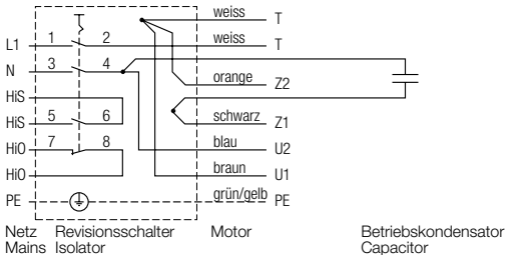

Revisionsschalter/Isolator ESH 21-0030-25

für Einphasen-Wechselstrommotoren, mit Betriebskondensator und Thermokontakten

for single-phase A.C., with capacitor and thermal contacts

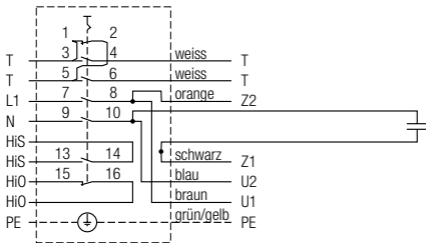

Netz Revisionschalter
Mains Isolator

Motor

Betriebskondensator
Capacitor

Revisionsschalter/Isolator ESH 21-0075-35

für Einphasen-Wechselstrommotoren, mit Betriebskondensator und Thermokontakten

for single-phase A.C., with capacitor and thermal contacts

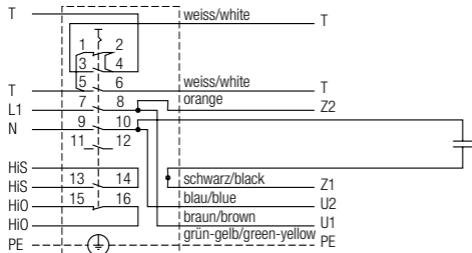

Netz
Mains

Revisionsschalter
Isolator

Motor

Betriebskondensator
capacitor

01-11-01

510

Revisionsschalter/Isolator ESH 21-0030-65 / ESH 21-0075-65
 für Drehstrommotoren, 2 Drehzahlen, 2 getrennte Wicklungen Y/Y,
 mit Thermokontakten
 for three-phase A.C., 2 speeds, two separate windings Y/Y-Connection,
 with thermal contacts

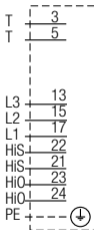

Netz
 Mains
 niedere Drehzahl/low speed

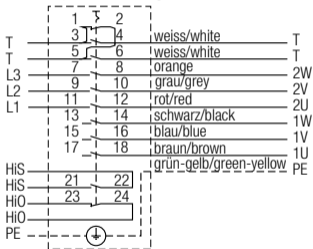

Netz Revisionsschalter Motor
 Mains Isolator
 hohe Drehzahl/high speed

Revisionsschalter ESH 21-0030-65 / ESH 21-0075-65

für Drehstrommotoren, 2 Drehzahlen, 2 getrennte Wicklungen Y/Y,
mit Thermokontakten

for three-phase A.C., 2 speeds, two separate windings Y/Y-Connection,
with thermal contacts

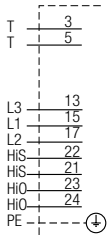

Netz
Mains

niedere Drehzahl/low speed

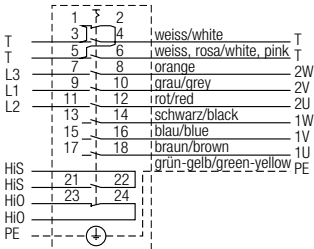

Netz Revisionsschalter
Mains Isolator

hohe Drehzahl/high speed

Motor

Revisionsschalter/Isolator ESH 21-0030-65 / ESH 21-0075-65
 für Drehstrommotoren, 2 Drehzahlen, Dahlanderschaltung Y/YY,
 mit Thermokontakten
 for three-phase A.C., 2 speeds, DAHLANDER Y/YY-Connection,
 with thermal contacts

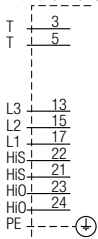

Netz
 Mains
 niedrigere Drehzahl/low speed

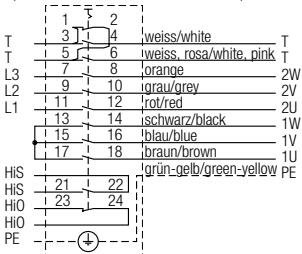

Netz Revisionsschalter
 Mains Isolator
 hohe Drehzahl/high speed

Motor

Revisionsschalter/Isolator ESH 21-0030-65 / ESH 21-0075-65
 für Drehstrommotoren, 2 Drehzahlen, Dahlanderschaltung Y/YY,
 mit Thermokontakten
 for three-phase A.C., 2 speeds, DAHLANDER Y/YY-Connection,
 with thermal contacts

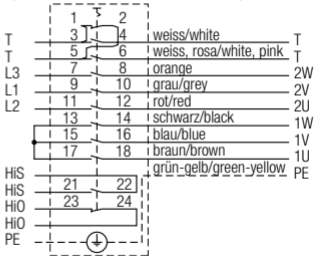
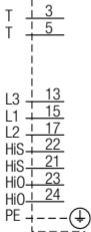

Netz
 Mains
 niedrigere Drehzahl/low speed

Netz Revisionsschalter
 Mains Isolator
 hohe Drehzahl/high speed

Motor

Revisionsschalter/Isolator ESH 21-0030-65 / ESH 21-0075-65
 für Drehstrommotoren, 2 Drehzahlen, Y/Δ-Schaltung, mit Thermokontakten
 for three-phase A.C., 2 speeds, Y/Δ-Connection, with thermal contacts

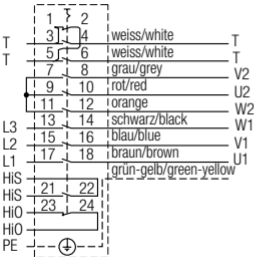

Netz Revisionsschalter Motor Y
 Mains Isolator
 niedere Drehzahl/low speed

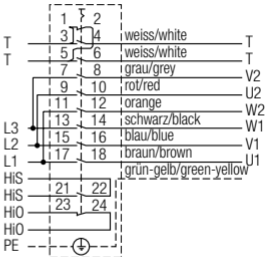

Netz Revisionsschalter Motor Δ
 Mains Isolator
 hohe Drehzahl/high speed

Revisionsschalter/Isolator ESH 21-0030-65 / ESH 21-0075-65
 für Drehstrommotoren, 2 Drehzahlen, Y/ Δ -Schaltung, mit Thermokontakten
 for three-phase A.C., 2 speeds, Y/ Δ -Connection, with thermal contacts

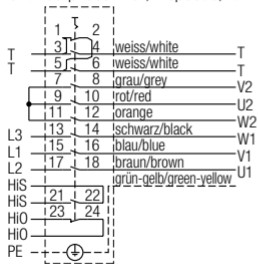

Netz Revisionsschalter Motor Y
 Mains Isolator

niedere Drehzahl/low speed

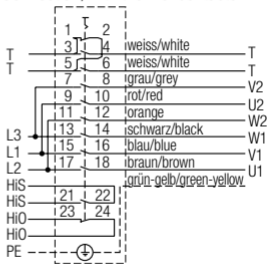

Netz Revisionsschalter Motor Δ
 Mains Isolator

hohe Drehzahl/high speed 02-09-02 **516**

Revisionsschalter/Isolator ESH 21/23-0055-32 bis ESH 21/23-0900-32
 für Drehstrommotoren, 1 Drehzahl, Y/ Δ -Schaltung
 for three-phase A.C., 1 speed, Y/ Δ -Connection

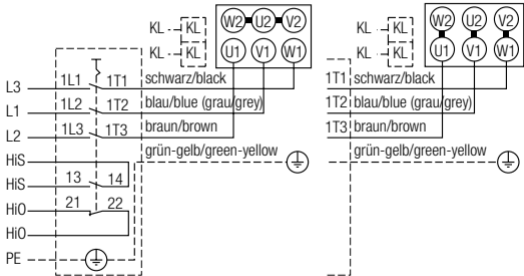

Netz Revisionschalter
 Mains Isolator

Motor Y

Motor Δ

Revisionsschalter/Isolator ESH 21/23-0075-62 bis ESH 21/23-0750-62
 für Drehstrommotoren, 1 Drehzahl, Y/ Δ -Anschluss
 for three-phase A.C., 1 speed, Y/ Δ -Connection

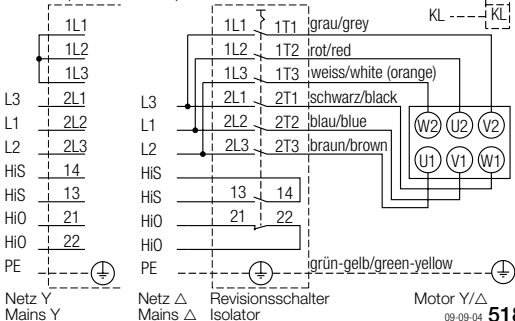

Revisionsschalter/Isolator ESH 21/23-0075-62 bis ESH 21/23-0750-62
 für Drehstrommotoren, 2 Drehzahlen, Dahlanderschaltung Y/YY
 for three-phase A.C., 2 speeds, DAHLANDER Y/YY-Connection

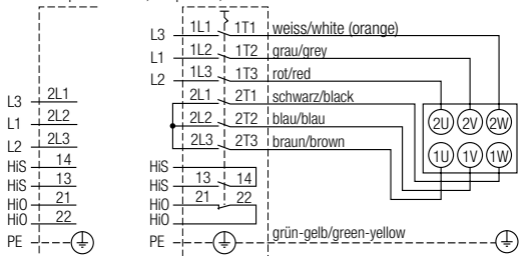

Netz
Mains
niedere Drehzahl
low speed

Netz Revisionsschalter
Mains Isolator
hohe Drehzahl
high speed

Motor Y/YY

Revisionsschalter/Isolator ESH 21/23-0075-62 bis ESH 21/23-0750-62
 für Drehstrommotoren, 2 Drehzahlen, getrennte Wicklung Y/Y
 for three-phase A.C., 2 speeds, two separate windings Y/Y-Connection

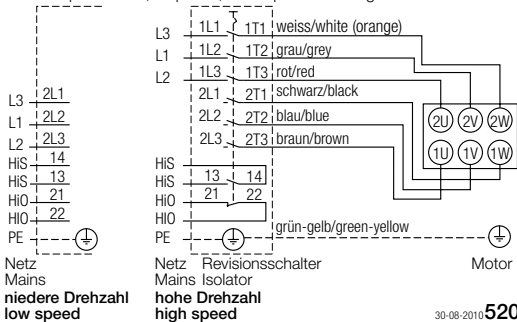

Revisionsschalter/Isolator ESH 21-0075-95

für Drehstrommotoren, 3 Drehzahlen, Dahlanderschaltung Y/YY,
 getrennte Wicklung für mittlere Drehzahl, mit Thermokontakten
 for three-phase A.C., 3 speeds, DAHLANDER Y/YY-Connection,
 with separate windings for middle speed, with thermal contacts

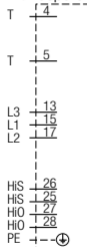

Netz/Mains
 niedrige Drehzahl
 low speed

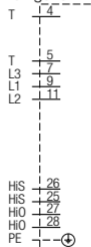

Netz/Mains
 mittlere Drehzahl
 middle speed

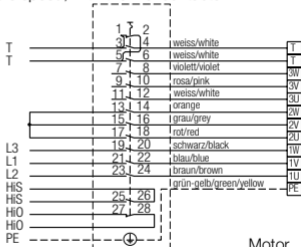

Netz/Mains
 hohe Drehzahl
 high speed

Revisionsschalter
 Isolator

Motor
 Y/YY, Y

Revisionsschalter/Isolator ESH 21-0030-65 / ESH 21-0075-65
 für Drehstrommotoren, 2 Drehzahlen, mit Vorschalttransformator Y/Y,
 mit Thermokontakten
 for three-phase A.C., 2 speeds, with Energy-saving transformer Y/Y, with
 thermal contacts

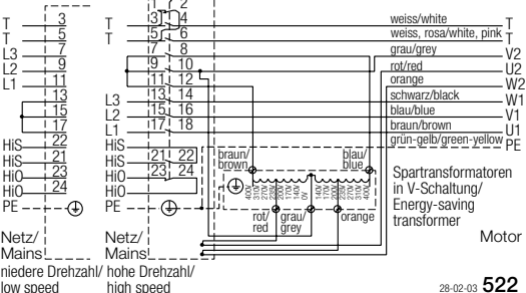

Revisionsschalter/Isolator ESH 21-0075-35

für Drehstrommotoren, 1 Drehzahl, Y/ Δ -Schaltung mit Thermokontakten

for three-phase A.C., single speed, Y/ Δ -Connection, with thermal contacts

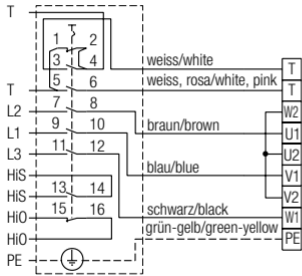

Netz Revisionsschalter
Mains Isolator

Motor Y

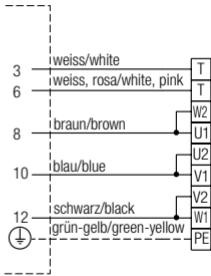

Motor Δ

Revisionsschalter/Isolator ESH 21-0055-65

für Drehstrommotoren, 2 Drehzahlen, Dahlanderschaltung Y/YY,
mit Thermokontakten

for three-phase A.C., 2 speeds, DAHLANDER Y/YY-Connection,
with thermal contacts

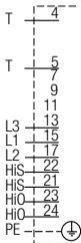

Netz
Mains
niedere Drehzahl/low speed

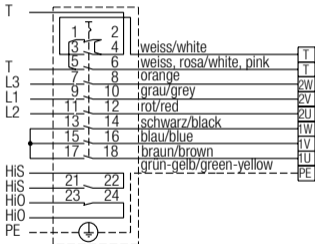

Netz Revisionsschalter
Mains Isolator

Motor

hohe Drehzahl/high speed

Revisionsschalter/Isolator ESH 21-0055-65

für Drehstrommotoren, 2 Drehzahlen, 2 getrennte Wicklungen Y/Y, mit Thermokontakten

for three-phase A.C., 2 speeds, two separate windings Y/Y-Connection, with thermal contacts

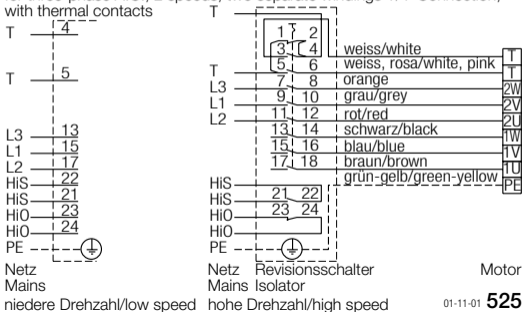

Revisionsschalter/Isolator ESH 21-0030-62

für Einphasen-Wechselstrommotoren, 2 Drehzahlen, mit Thermokontakten
 for single-phase A.C., 2 speeds, with thermal contacts

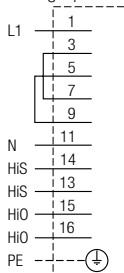

Netz
Mains

niedere Drehzahl/low speed

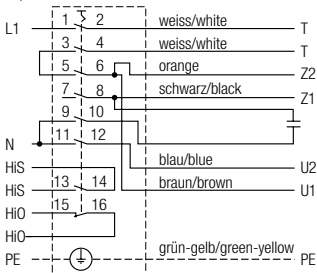

Netz Revisionsschalter
Mains Isolator

hohe Drehzahl/high speed

Motor

Revisionsschalter/Isolator ESH 21-0030-35

für Drehstrommotoren, 1 Drehzahl, mit Thermokontakt, Y/ Δ -Schaltung
 for three-phase A.C., single speed Y/ Δ , with thermal contacts

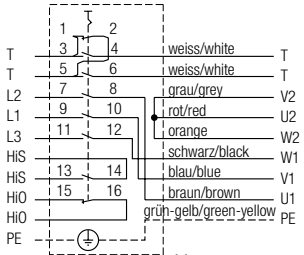

Netz Revisionschalter
 Mains Isolator

Motor
 Y-Schaltung 400 V
 Y-Connection

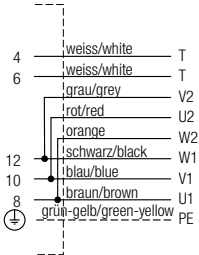

Motor
 Δ -Schaltung 230 V
 Δ -Connection

Revisionsschalter/Isolator ESH 21-0030-32
 für Drehstrommotoren, 1 Drehzahl, Y/ Δ -Schaltung
 for three-phase A.C., single speed, Y/ Δ -Connection

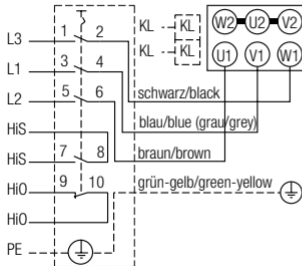

Netz Revisionsschalter
 Mains Isolator

Motor Y

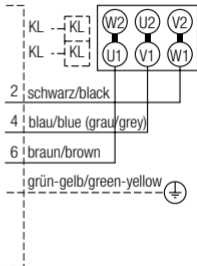

Motor Δ

Revisionsschalter/Isolator ESH 21-0030-62
 für Drehstrommotoren, 1 Drehzahl, Y/ Δ -Schaltung
 for three-phase A.C., single speed, Y/ Δ -Connection

KL --- KL
 KL --- KL

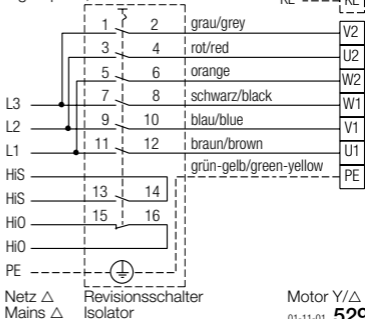
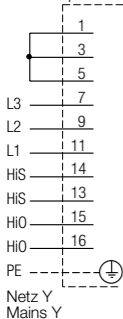

Revisionsschalter/Isolator ESH 21-0030-62

für Drehstrommotoren, 2 Drehzahlen, Dahlanderschaltung Y/YY
 for three-phase A.C., 2 speeds, DAHLANDER Y/YY-Connection

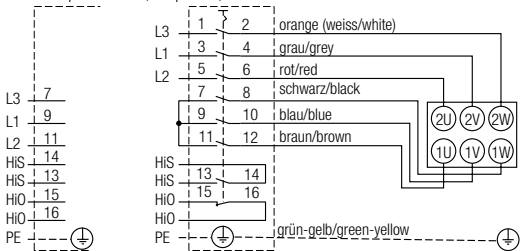

Netz
Mains
niedere Drehzahl
low speed

Revisionsschalter
Mains Isolator
hohe Drehzahl
high speed

Motor

Revisionsschalter/Isolator ESH 21-0030-62

für Drehstrommotoren, 2 Drehzahlen, getrennte Wicklung Y/Y

for three-phase A.C., 2 speeds, two separate windings Y/Y-Connection

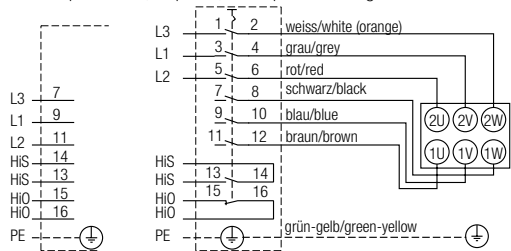

Netz
Mains

Netz Revisionsschalter
Mains Isolator

Motor

niedere Drehzahl
low speed

hohe Drehzahl
high speed

Schaltbild
für Drehstrommotoren, 2 Drehzahlen, mit Vorschalttransformator Y/Y, mit
Thermokontakten
for three-phase A.C., 2 speeds, with Energy-saving transformer Y/Y, with
thermal contacts

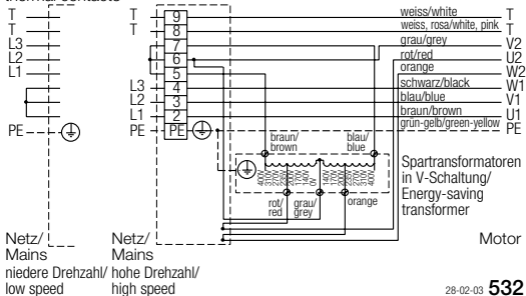

Revisionsschalter/Isolator ESH 21-0075-35

für Drehstrommotoren, 1 Drehzahl, Y-Schaltung mit Thermokontakten
 for three-phase A.C., 1 speed, Y-Connection, with thermal contacts

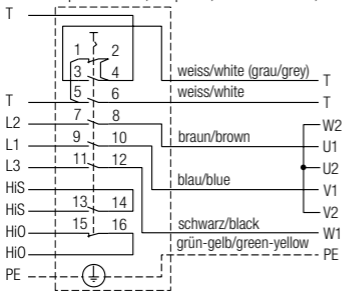

Netz Revisionschalter
 Mains Isolator

Motor

Revisionsschalter/Isolator ESH 21-0030-35

für Drehstrommotoren, 1 Drehzahl, Y/ Δ -Schaltung mit Thermokontakten
 for three-phase A.C., single speed, Y/ Δ -Connection, with thermal contacts

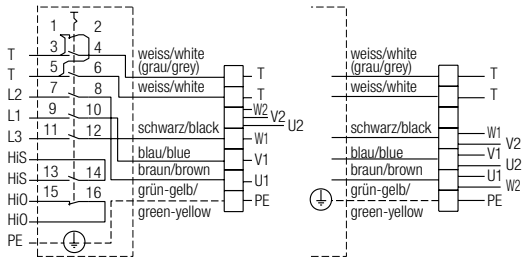

Netz/
Mains

Revisionsschalter/
Isolator

Motor Y

Motor Δ

Revisionsschalter/Isolator ESH 21-0030-65 / ESH 21-0075-65
 für Drehstrommotoren, 2 Drehzahlen, mit Vorschalttransformator Y/Y, mit
 Thermokontakten
 for three-phase A.C., 2 speeds, with Energy-saving transformer Y/Y, with
 thermal contacts

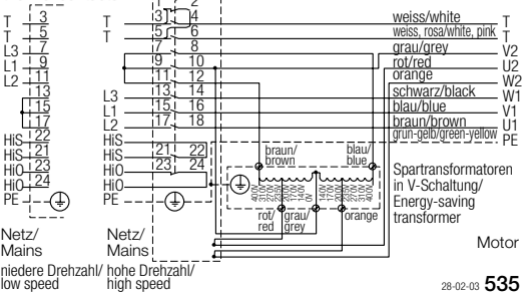

Schaltbild

für Drehstrommotoren, 2 Drehzahlen, mit Vorschalttransformator Y/Y, mit Thermokontakten

for three-phase A.C., 2 speeds, with Energy-saving transformer Y/Y, with thermal contacts

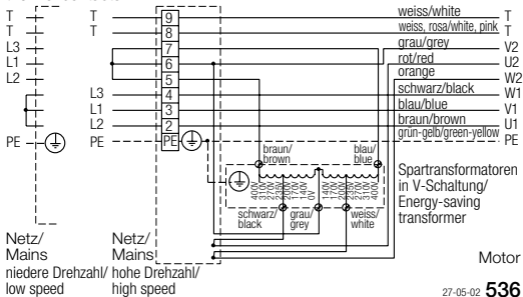

Revisionsschalter/Isolator ESH 21-0030-35

für Drehstrommotoren, 1 Drehzahl, Δ -Schaltung, mit Thermokontakten
 for three-phase A.C., single speed, Δ -Connection, with thermal contacts

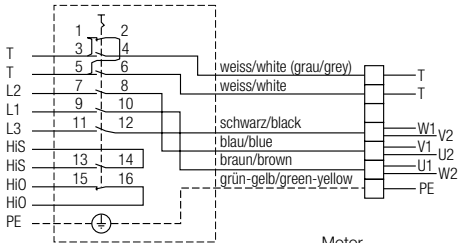

Netz Revisionsschalter
 Mains Isolator

Motor
 Δ -Schaltung 400 V
 Δ -Connection

Revisionsschalter/Isolator ESH 21-0075-62 bis ESH 21-0750-62
 für Drehstrommotoren, 1 Drehzahl, Y/ Δ -Anlauf
 for three-phase A.C., 1 speed, Y/ Δ -Connection

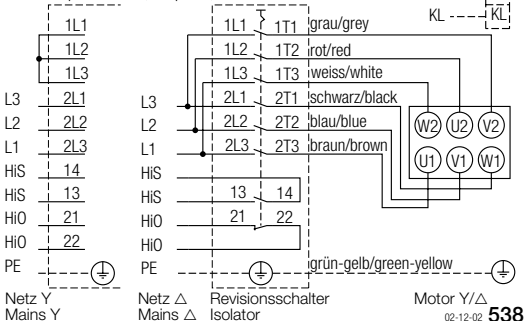

Revisionsschalter/Isolator ESH 21-0030-32
 für Drehstrommotoren, 1 Drehzahl, Y/ Δ -Schaltung
 for three-phase A.C., single speed, Y/ Δ -Connection

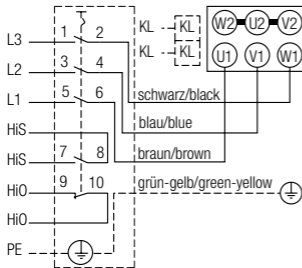

Netz Revisionsschalter
 Mains Isolator

Motor Y

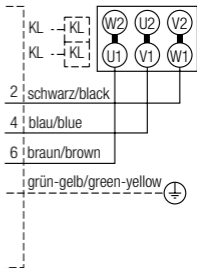

Motor Δ

Revisionsschalter/Isolator ESH 21-0055-32 bis ESH 21-0900-32
 für Drehstrommotoren, 1 Drehzahl, Y/ Δ -Schaltung
 for three-phase A.C., 1 speed, Y/ Δ -Connection

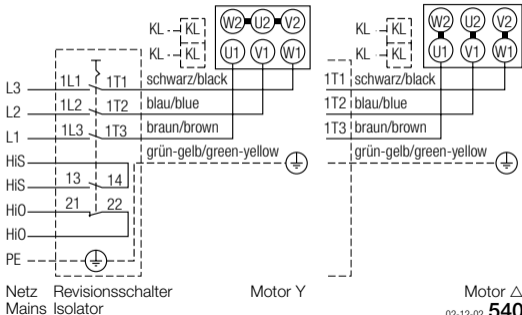

Revisionsschalter/Isolator ESH 22-0075-32 bis ESH 21-0900-32
 für Drehstrommotoren, 1 Drehzahl, Y/ Δ -Schaltung
 for three-phase A.C., 1 speed, Y/ Δ -Connection

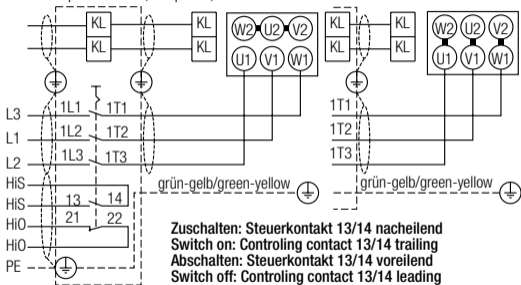

Netz Revisionschalter
 Mains Isolator

Motor Y

Motor Δ

Revisionsschalter/Isolator ESH 21-0030-62

für Drehstrommotoren, 2 Drehzahlen, Dahlanderschaltung Y/YY
 for three-phase A.C., 2 speeds, DAHLANDER Y/YY-Connection

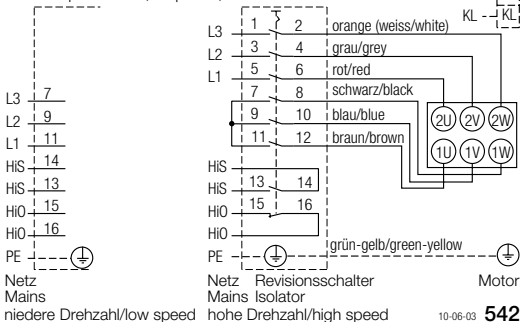

Revisionsschalter/Isolator ESH 21-0075-62 ... ESH 21-0750-62

für Drehstrommotoren, 1 Drehzahl, Y/ Δ -Anlauf
 for three-phase A.C., 1 speed, Y/ Δ -Connection

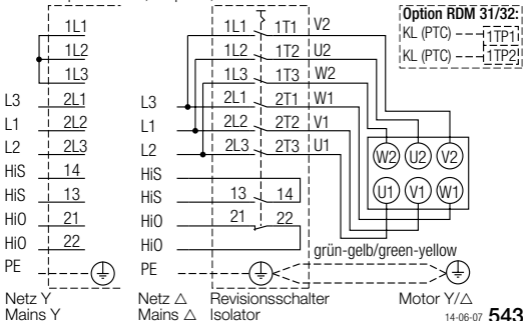

Revisionsschalter/Isolator ESH 21/23-0075-62 ... ESH 21/23-0750-62

für Drehstrommotoren, 2 Drehzahlen, Dahlanderschaltung Y/YY

for three-phase A.C., 2 speeds, DAHLANDER Y/YY-Connection

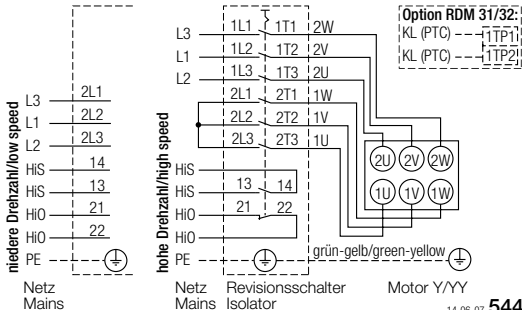

Revisionsschalter/Isolator ESH 21/23-0075-62 ... ESH 21/23-0750-62

für Drehstrommotoren, 2 Drehzahlen, getrennte Wicklung
for three-phase A.C., 2 speeds, two separate windings

for three-phase A.C., 2 speeds, two separate windings

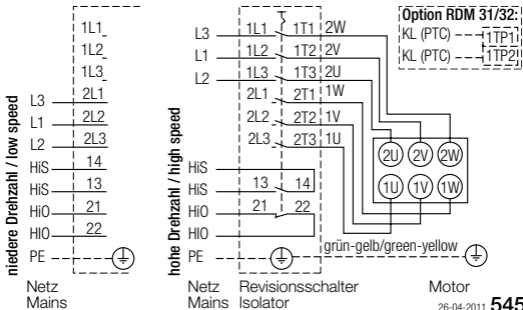

Revisionsschalter/Isolator ESH 21-0030-35 / ESH 21-0075-35
 für Drehstrommotoren, 1 Drehzahl, Y-Schaltung mit Thermokontakten
 for three-phase A.C., 1 speed, Y-Connection, with thermal contacts

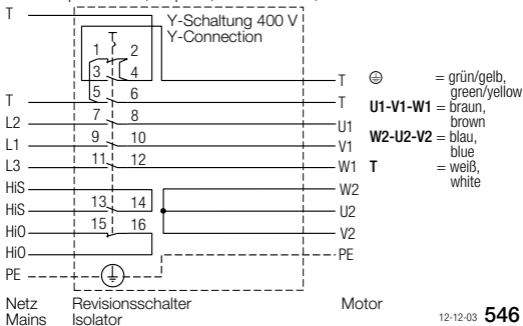

Revisionsschalter/Isolator ESH 22-0075-62
 für Drehstrommotoren, 1 Drehzahlen, Y-Schaltung
 for three-phase A.C., 1 speeds, Y-Connection

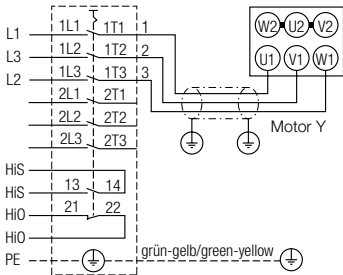

Netz Revisionschalter
 Mains Isolator

Revisionsschalter/Isolator ESH 21-0030-35 / ESH 21-0075-35
 für Drehstrommotoren, 1 Drehzahl, Y-Schaltung mit Thermokontakten
 for three-phase A.C., single speed, Y-Connection, with thermal contacts

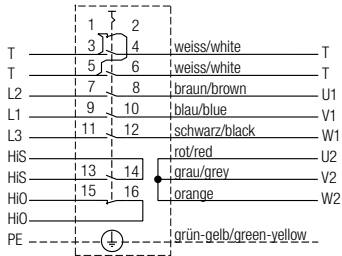

Netz/
Mains

Revisionsschalter/
Isolator

Y-Schaltung 400 V
Y-Connection

Revisionsschalter/Isolator ESH 21-0030-35 / ESH21-0075-35
 für Drehstrommotoren, 1 Drehzahl, Δ -Schaltung mit Thermokontakten
 for three-phase A.C., 1 speed, Δ -Connection, with thermal contacts

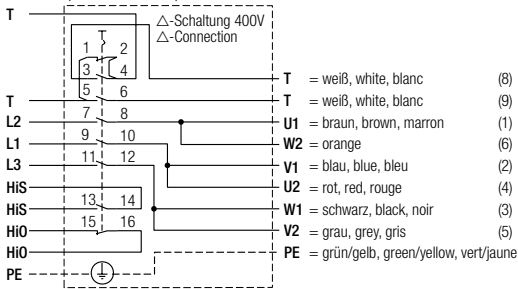

Netz Mains
 Revisionsschalter Isolator

Motor

Revisionsschalter ESH 21-0030-65 / ESH 21-0075-65

für Drehstrommotoren, 2 Drehzahlen, 2 getrennte Wicklungen Y/Y,
mit Thermokontakten

for three-phase A.C., 2 speeds, two separate windings Y/Y-Connection,
with thermal contacts

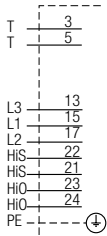

Netz
Mains

niedere Drehzahl/low speed

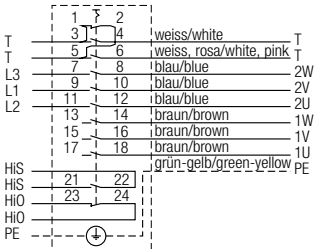

Netz Revisionsschalter
Mains Isolator

hohe Drehzahl/high speed

Motor

Revisionsschalter/Isolator ESH 21-0030-65 / ESH 21-0075-65
 für Drehstrommotoren, 2 Drehzahlen, Dahlanderschaltung Y/YY, mit Thermokontakten
 for three-phase A.C., 2 speeds, DAHLANDER Y/YY-Connection, with thermal contacts

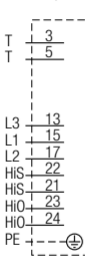

Netz
Mains

niedere Drehzahl
low speed

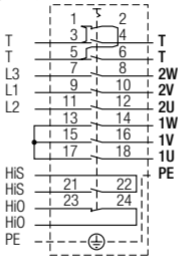

Netz Revisionschalter Motor
Mains Isolator

hohe Drehzahl
high speed

- ⊕ = grün/gelb,
green/yellow,
vert/jaune
- 1U = braun, brown, marron
- 1V = blau, blue, bleu
- 1W = schwarz, black, noir
- 2U = rot, red, rouge
- 2V = grau, grey, gris
- 2W = orange
- T = weiß, white, blanc

Revisionsschalter/Isolator ESH 21-0030-62

für Drehstrommotoren, 1 Drehzahl, Y - 400 V mit Stillstandheizung 230 V
for three-phase A.C., single speed, Y - 400 V with Pre-heater 230 V

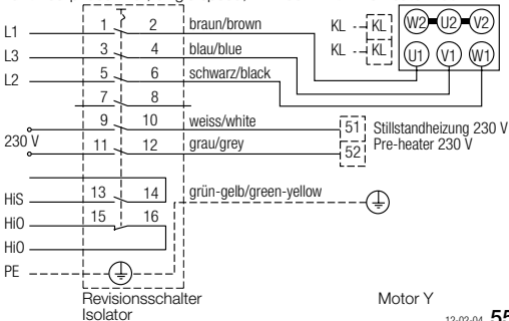

Revisionsschalter/Isolator ESH 21-0055-62 bis ESH 21-0750-62
für Drehstrommotoren, 2 Drehzahlen, getrennte Wicklung Y/Y
for three-phase A.C., 2 speeds, two separate windings Y/Y-Connection

niedere Drehzahl
low speed

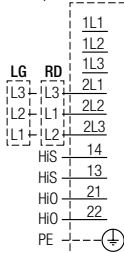

hohe Drehzahl
high speed

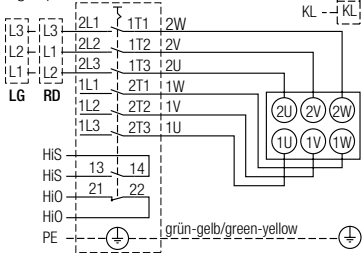

Netz
Mains

Netz
Mains
Revisionsschalter
Isolator

Motor
04-10-05 **553**

Revisionsschalter/Isolator ESH 21-0055-62 bis ESH 21-0750-62
für Drehstrommotoren, 2 Drehzahlen, Dahlanderschaltung Y/YY
for three-phase A.C., 2 speeds, DAHLANDER Y/YY-Connection

niedere Drehzahl
low speed

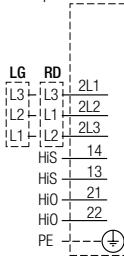

hohe Drehzahl
high speed

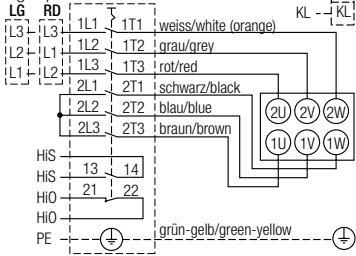

Netz
Mains

Netz
Mains

Revisionsschalter
Isolator

Motor Y/YY

31-05-12 **554**

Revisionsschalter/Isolator ESH 21-0055-32 bis ESH 21-0900-32
 für Drehstrommotoren, 1 Drehzahl, Y/ Δ -Schaltung
 for three-phase A.C., 1 speed, Y/ Δ -Connection

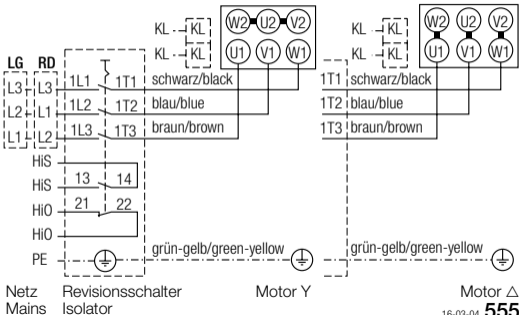

Revisionsschalter/Isolator ESH 21-0055-62 bis ESH 21-0090-62
 für Drehstrommotoren, 1 Drehzahl, Y/Δ-Anlauf
 for three-phase A.C., 1 speed, Y/Δ-Connection

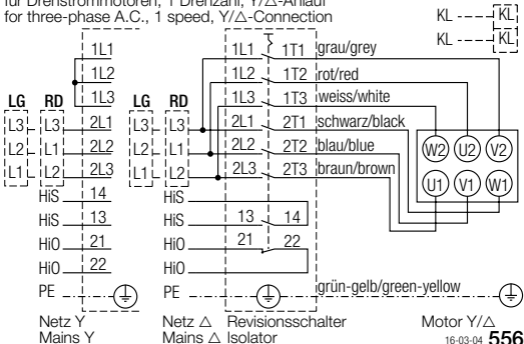

Revisionschalter / Isolator ESH 21-0030-32

für Drehstrommotoren,
1 Drehzahl, Y/ Δ -Schaltungung
for three-phase A.C.,
single speed,
Y/ Δ -Connection

Y - JUMPER

alternative

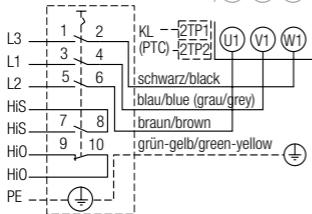

Netz Revisionschalter
Mains Isolator

Motor Y

Neue Ausführung
New models

Δ - JUMPER

Frühere Modelle
Prior models

alternative

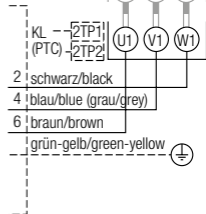

Motor Δ

Revisionschalter/Isolator ESH 21/23-0055-32 bis ESH 21/23-0900-32
 für Drehstrommotoren, 1 Drehzahl, Y/ Δ -Schaltung
 for three-phase A.C., 1 speed, Y/ Δ -Connection

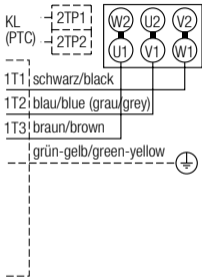
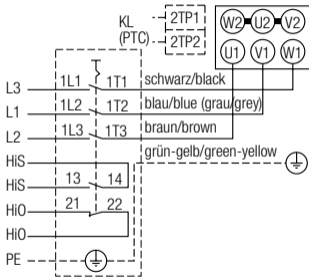

Netz Revisionschalter
 Mains Isolator

Motor Y

Motor Δ

Revisionsschalter/Isolator ESH 21/23-0075-62 bis ESH 21/23-0750-62
 für Drehstrommotoren, 1 Drehzahl, Y/ Δ -Anschluss
 for three-phase A.C., 1 speed, Y/ Δ -Connection

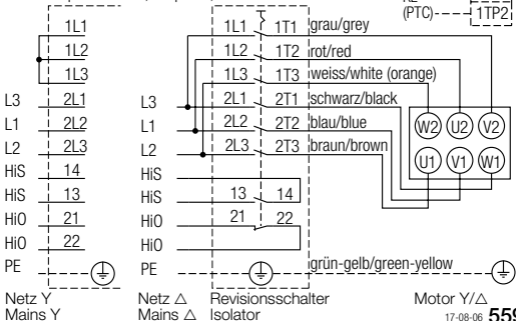

Revisionsschalter/Isolator ESH 21-0030-62

für Drehstrommotoren, 2 Drehzahlen, getrennte Wicklung Y/Y

for three-phase A.C., 2 speeds, two separate windings Y/Y-Connection

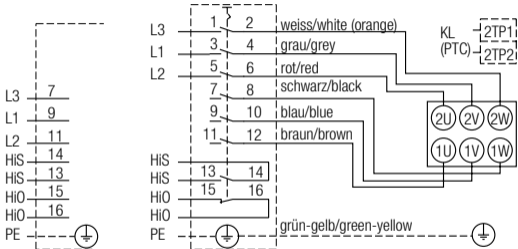

Netz
Mains

Netz Revisionschalter
Mains Isolator

Motor

niedere Drehzahl
low speed

hohe Drehzahl
high speed

Revisionsschalter/Isolator ESH 21/23-0075-62 bis ESH 21/23-0750-62
 für Drehstrommotoren, 2 Drehzahlen, getrennte Wicklung Y/Y
 for three-phase A.C., 2 speeds, two separate windings Y/Y-Connection

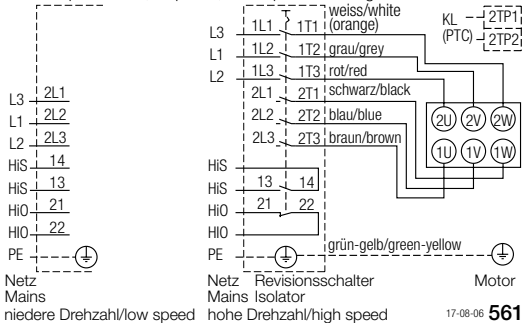

Revisionsschalter/Isolator ESH 21-0030-62

für Drehstrommotoren, 2 Drehzahlen, Dahlanderschaltung Y/YY
 for three-phase A.C., 2 speeds, DAHLANDER Y/YY-Connection

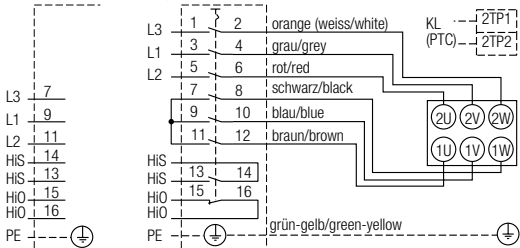

niedere Drehzahl
low speed

hohe Drehzahl
high speed

Revisionsschalter/Isolator ESH 21/23-0075-62 bis ESH 21/23-0750-62
 für Drehstrommotoren, 2 Drehzahlen, Dahlanderschaltung Y/YY
 for three-phase A.C., 2 speeds, DAHLANDER Y/YY-Connection

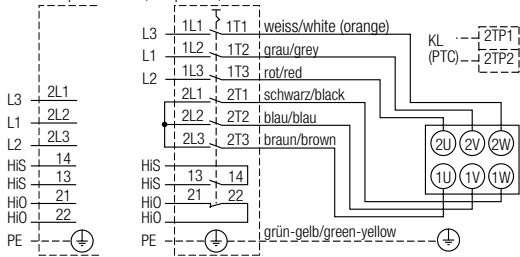

Netz
Mains
niedere Drehzahl
low speed

Netz Revisionsschalter
Mains Isolator
hohe Drehzahl
high speed

Motor Y/YY

Revisionsschalter/Isolator ESH 21-0030-32
 für Drehstrommotoren, 1 Drehzahl, Y-Schaltung
 for three-phase A.C., single speed, Y-Connection

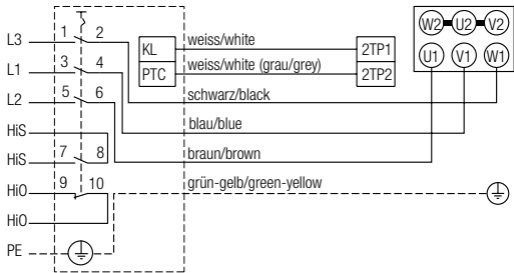

Netz Revisionsschalter
 Mains Isolator

Motor Y

Revisionsschalter/Isolator ESH 21-0030-22

Spaltpolmotor, Thermokontakte in der Motorwicklung verschaltet

Split-pole motor, thermal contacts in series with the motor winding

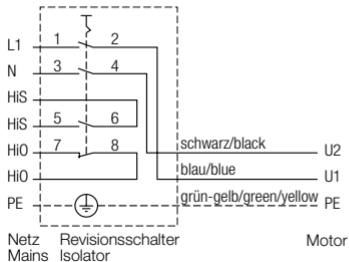

Revisionsschalter/Isolator ESH 21-0030-25

für Einphasen-Wechselstrommotoren, mit Betriebskondensator und Thermokontakten

for single-phase A.C., with capacitor and thermal contacts

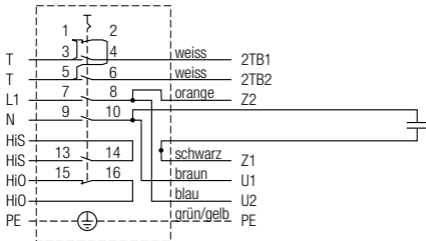

Netz Revisionschalter
Mains Isolator

Motor

Betriebskondensator
Capacitor

Revisionsschalter / Isolator ESH 21-0075-65 / ESH21-0110-65
 für Drehstrommotoren, 1 Drehzahl, Δ -Schaltung mit Thermokontakten
 for three-phase A.C., 1 speed, Δ -Connection, with thermal contacts

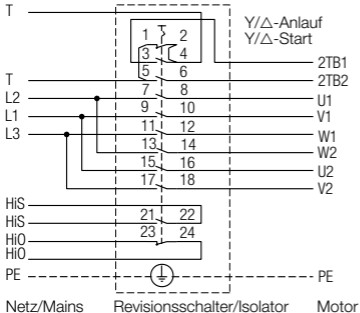

- ⊕ = grün/gelb,
green/yellow
- U1-V1-W1** = braun,
brown
- W2-U2-V2** = blau,
blue
- 2TB** = weiß,
white

Revisionsschalter ESH 21-0030-32 für Drehstrommotoren, 1 Drehzahl, Y-Schaltung
Isolator ESH 21-0030-32 for three-phase A.C., single speed, Y-Connection

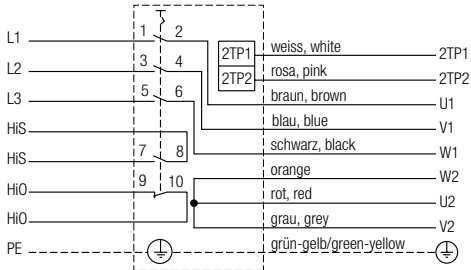

Netz
Mains

Revisionsschalter
Isolator

16-04-08

568

Revisionschalter ESH 21-0030-62 für Drehstrommotoren, 2 Drehzahlen,
 Dahlanderschaltung Y/YY (bzw. PAM Schaltung)

Isolator ESH 21-0030-62 for three-phase A.C., 2 speeds, DAHLANDER (PAM) Y/YY-Connection

niedere Drehzahl
 low speed

hohe Drehzahl
 high speed

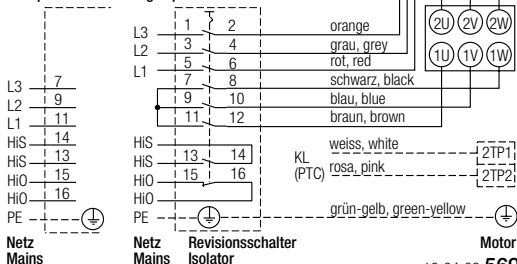

Revisionsschalter/Isolator ESH 21-0030-35

für Drehstrommotoren, 1 Drehzahl, Δ -Schaltung, mit Thermokontakten
 for three-phase A.C., single speed, Δ -Connection, with thermal contacts

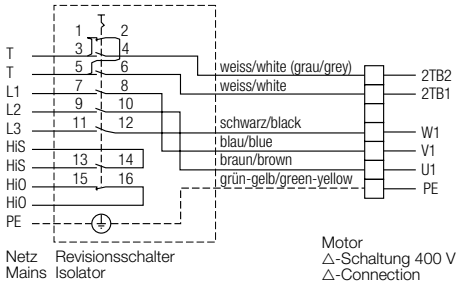

Revisionsschalter / Isolator ESH 21-0075-65 / ESH21-0110-65
 für Drehstrommotoren, 1 Drehzahl, Δ -Schaltung mit Thermokontakten
 for three-phase A.C., 1 speed, Δ -Connection, with thermal contacts

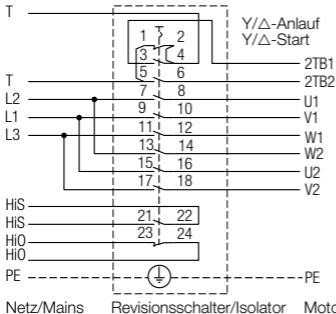

⊕ = grün/gelb, green/yellow, vert/jaune

U1 = braun, brown, marron

V1 = blau, blue, bleu

W1 = schwarz, black, noir

U2 = rot, red, rouge

V2 = grau, grey, gris

W2 = orange

2TB = weiß, white, blanc

Revisionsschalter / Isolator ESH21-0110-62

für Drehstrommotoren, 1 Drehzahl, Δ -Schaltung mit Thermokontakten
 for three-phase A.C., 1 speed, Δ -Connection, with thermal contacts

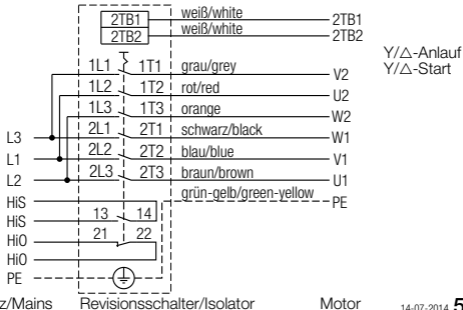

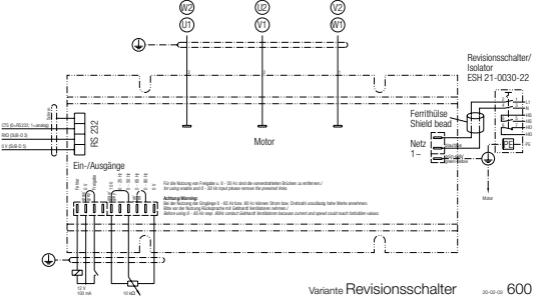

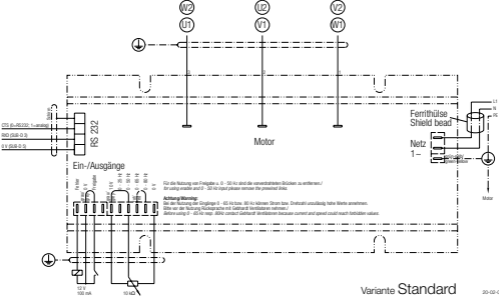

Für die Nutzung von Frequenzen 0 - 50 Hz sind die verarbeiteten Blöcke zu entfernen!
 For using modes and 0 - 50 Hz input please remove the provided block.

Achtung/Warning:

Bei der Nutzung der Eingänge 0 - 50 Hz bzw. 60 Hz können Strom bzw. Drehzahl unzulässig hohe Werte annehmen.
 Bitte vor der Nutzung Rücksperrdiode mit Gehörstrecke Verkleben nehmen!
 Before using 0 - 50 Hz resp. 60Hz connect Gehörstrecke Verkleben because current and speed could reach forbidden values.

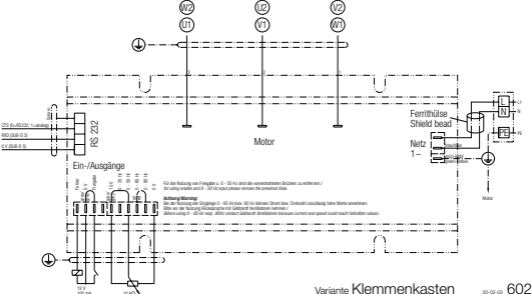

Revisionschalter / Isolator ESH 21-0030-22

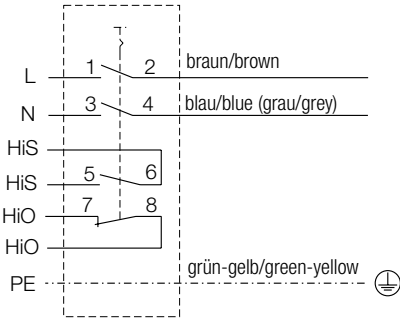

Netz / Mains 230 V ~

19-06-06

604

Revisionsschalter / Isolator ESH 21-0030-25

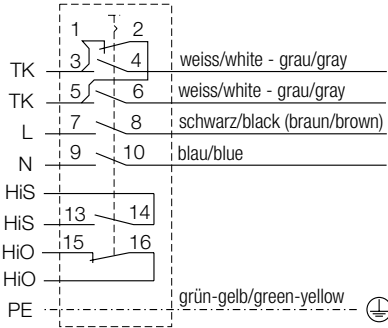

Netz / Mains 230 V ~

05-12-2012

605

Revisionschalter / Isolator ESH 21-0030-22

Netz /
Mains
230 V ~

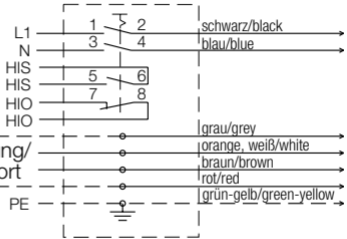

Störmeldung/
Faults report

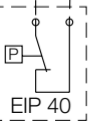

Revisionsschalter / Isolator ESH 21-0030-22

Netz /
Mains
230 V ~

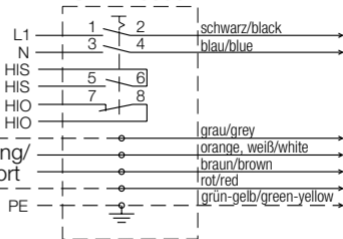

Störmeldung/
Faults report

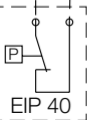

Revisionsschalter | Isolator
ESH 21-0030-22

Ferrithülse
Shield bead

Netz |
Mains
230 V~

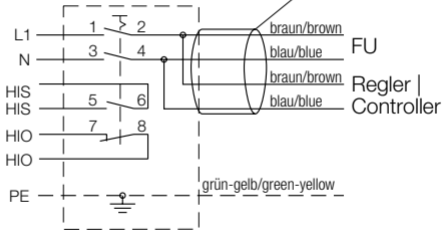

Revisionschalter | Isolator ESH 21-0030-22

Netz | Mains
230 V~

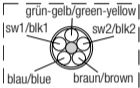

Achtung!
abgeschirmte
Steuerkabel
verwenden!

Note!
use only
shielded
control
cables!

Störmeldung |
Fault signal
Option:
ETG 02-0024-5E

0-10V out
0-10V in
GND
0-5V in
+5V out

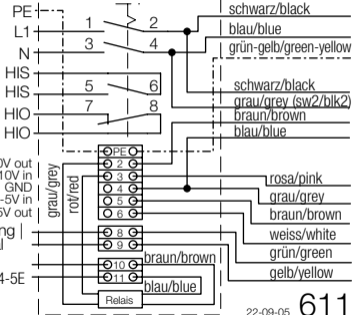

22-09-05

611

Revisionschalter | Isolator ESH 21-0030-22

Netz | Mains
230 V~

Achtung!
abgeschirmte
Steuerkabel
verwenden!

Note!
use only
shielded
control
cables!

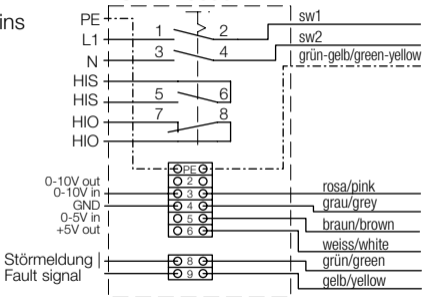

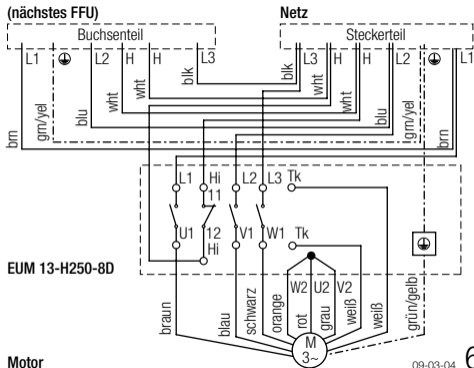

Revisionsschalter | Isolator ESH 21-0030-22

Netz |
Mains
230 V~

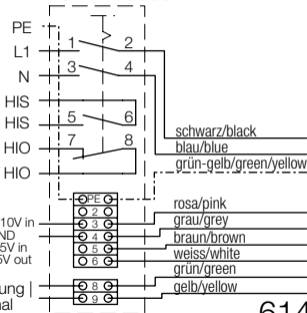

Achtung! abgeschirmte
Steuerkabel verwenden!
Note! use only shielded
control cables!

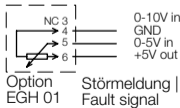

Netz | Revisionschalter | Isolator
 Mains | ESH 21-0030-22
 230 V~

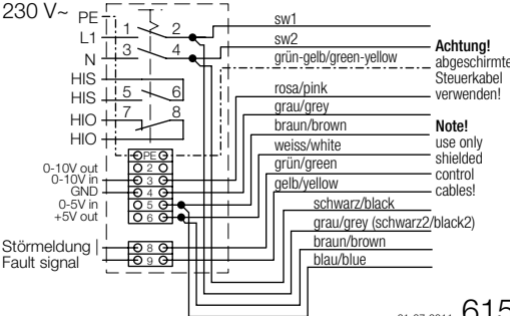

Revisionschalter | Isolator ESH 21-0030-22

Netz |
Mains
230 V~

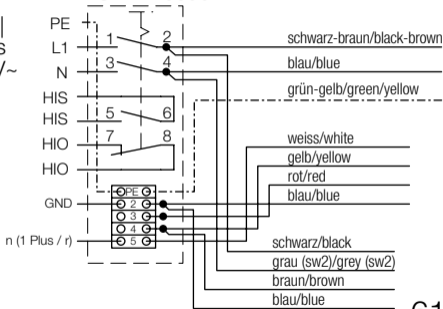

06-07-06

616

Revisionschalter | Isolator ESH 21-0030-22

Netz |
Mains
230 V~

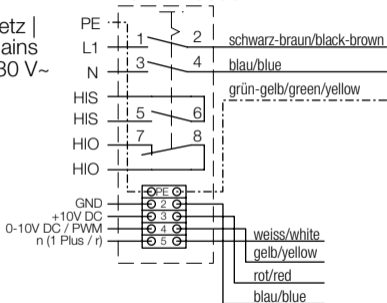

Revisionsschalter | Isolator ESH 21-0030-22

Netz |
Mains
230 V~

Option EGH 01

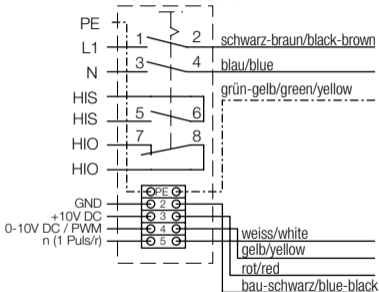
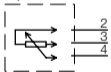

Netz | Mains 230 V~

Revisionschalter | Isolator
ESH 21-0030-22

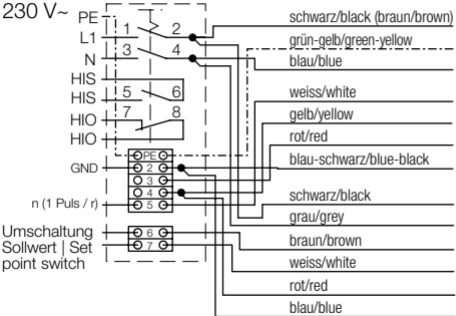

Revisionschalter | Isolator

ESH 21-0030-22

Netz |
Mains
230 V~

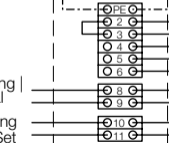
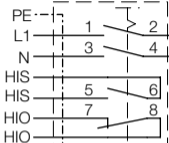

Störmeldung |
Fault signal

Umschaltung
Sollwert | Set
point switch

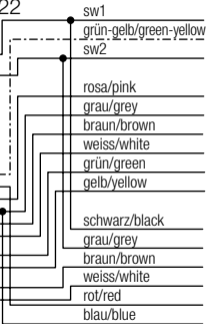

620

21-07-2011

Anschlüsse

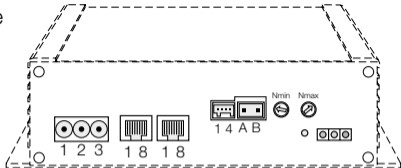

Netzanschluss
208...277 V
50...60 Hz

Analog Eingang

Fehlerkontakt Öffner

Fehler Reset

Fehler LED
Betriebs LED

Schnittstellen

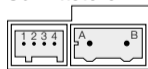

1=+5 V
2=0...10 V
3=0...5 V
4=Masse

A=Fehler-
kontakt
B=Fehler-
kontakt

Nmin



Nmin =
minimaler
Drehzahl-
wert

Nmax



Nmax =
maximaler
Drehzahl-
wert

Revisionsschalter
Isolator ESH 21-0030-22

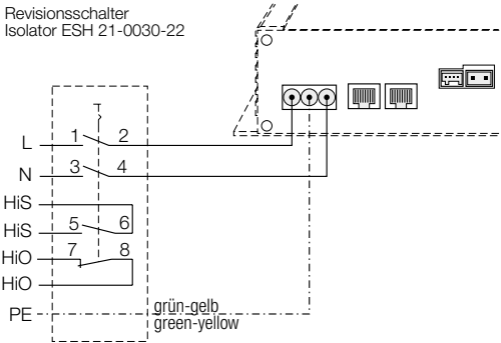

Netz / Mains 230 V ~

Revisionschalter / Isolator

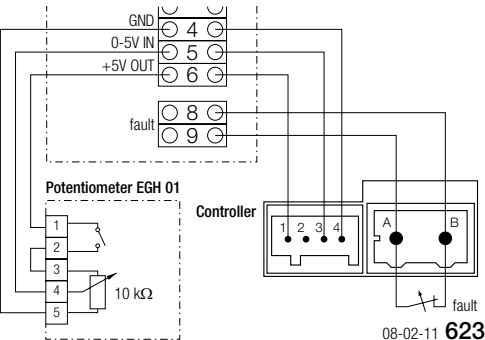

EC-Ventilator mit integrierter Elektronik
EC-fan with integrated electronics

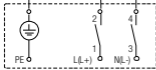
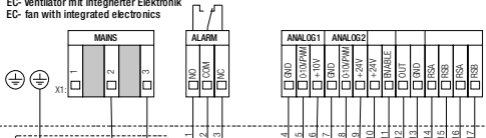

Geräteausschalter /
On / Off-Switch

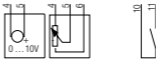

Betriebsart:
Operation Mode
a) Steuerbetrieb
open-loop
control

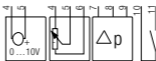

Betriebsart:
Operation Mode
b) Regelbetrieb
closed-loop
control

Die Umstellung der Betriebsart ist durch Umparametrierung des EC- Motors an der RS 485 Schnittstelle möglich!

Changing operation mode requires re-configuration of motor parameters via RS 485 interface!

EC-Ventilator mit integrierter Elektronik
EC-fan with integrated electronics

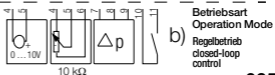
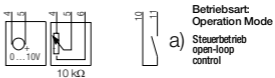
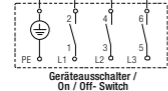
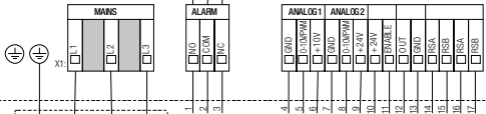

Die Umstellung der Betriebsart ist durch Umparametrierung des EC-Motors an der RS 485 Schnittstelle möglich!

Changing operation mode requires re-configuration of motor parameters via RS 485 interface!

EC- Ventilator mit integrierter Elektronik
 EC- fan with integrated electronics

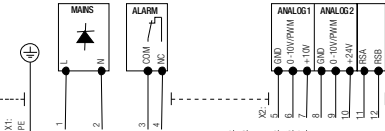

- X2:**
 Steuerkabel /
 control cable
- 5 braun / brown
 - 6 schwarz / black
 - 7 gelb / yellow
 - 8 blau / blue
 - 9 grün / green
 - 10 violett / violett
 - 11 rot / red
 - 12 orange

X1: PE
 1
 2
 3
 4
X1: Netzkabel / Mains cable



Betriebsart:
 Operation Mode

a) Steuerbetrieb
 open-loop
 control

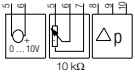

Betriebsart:
 Operation Mode

b) Regelbetrieb
 closed-loop
 control

Die Umstellung der Betriebsart ist durch
 Umparametrierung des EC- Motors an der
 RS 485 Schnittstelle möglich!

Changing operation mode requires
 re-configuration of motor parameters
 via RS 485 interface!

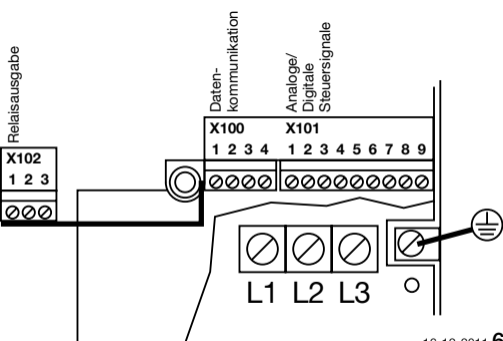

Nicotra Gebhardt weltweit

nicotra-gebhardt.com

AUSTRALIEN

65 Yale Drive,
Epping, VIC 3076
Telefon +61 3 9017 5333
Telefax +61 3 8401 3969
E-Mail info@nicotra.com.au

BELGIEN

Haeghensgoed, 13 - 00/01
9270 Laarne
Telefon +32 (0)9-336-00-01
Telefax +32 (0)9-336-00-05
E-Mail info.nicotra@nicotra.be

CHINA

88 Tai'An Road, XinQiao, ShiJi, Panyu
Guangzhou 511450
PR CHINA
Telefon +86 (0)20-2293 5700
Telefax +86 (0)20-2293 5701
E-Mail sales@nicotra-china.com

DEUTSCHLAND

Gebhardtstraße 19-25
74638 Waldenburg
Telefon +49 (0)7942 101 0
Telefax +49 (0)7942 101 170
E-Mail info@nicotra-gebhardt.com

FRANKREICH

Leader's Park Bat A1
3 chemin des Cytises
69340 Francheville
Telefon +33 (0)4 72 79 01 20
Telefax +33 (0)4 72 79 01 21
E-Mail f.burgevin@nicotra-gebhardt.com

GROSSBRITANNIEN

Unit D, Rail Mill Way
Parkgate Business Park
Rotherham
South Yorkshire
S62 6JQ
Telefon +044 01709-780760
Telefax +044 01709-780762
E-Mail sales@nicotra.co.uk

INDIEN

Plot no 28F & 29, Sector-31, Kasna,
Greater Noida-201 308 U.P (India)
Telefon +91 120 4783400
Telefon +91 22 65702056 (Mumbai)
Telefon +91 80 25727830 (Bangalore)
E-Mail info@nicotraindia.com

ITALIEN

Via Modena, 18
24040 Zingonia (BG)
Telefon +39 035 873 111
Telefax +39 035 884 319
E-Mail info@nicotra-gebhardt.com

Nicotra Gebhardt Deutschland

Nicotra Gebhardt GmbH
Gebhardtstraße 19-25
74638 Waldenburg
Deutschland
Telefon +49 (0)7942 101 0
Telefax +49 (0)7942 101 170
E-Mail info@nicotra-gebhardt.com



MALAYSIA

Lot 1799, Jalan Batakong
Taman Perindustrian Bukit Belimbing
43300 Seri Kembangan
Selangor
Telefon +603 8961-2588
Telefax +603 8961-8337
E-Mail info_malaysia@nicotra-gebhardt.com

SCHWEDEN

Kraketorpsgatan 30
43153 Mölndal
Telefon 0046 101-302600
Telefax 0046 31-878590
E-Mail info.se@nicotra-gebhardt.com

SINGAPUR

3, Science Park Drive, # 04-07, The Franklin
Singapore Science Park 1
Singapore 118223
Telefon +65 6265 1522
Telefax +65 6265 2400
E-Mail info_singapore@nicotra-gebhardt.com

SPANIEN

Ctra. Alcalá-Villar del Olmo, Km. 2,830
28810 Villalbilla-Madrid
Telefon +34 918-846110
Telefax +34 918-859450
E-Mail info@nicotra.es

THAILAND

6/29 Soi Suksawadi 2, Moo 4, Suksawadi Road,
Kwang Jomthong, Khet Jomthong,
Bangkok 10150
Telefon +662 476-1823-6
Telefax +662 476-1827
E-Mail sales@nicotra.co.th

USA

PO BOX 900921
Sandy, Utah 84090
Telefon 001(801) 733-0248
Telefax 001(801) 315-9400
Mobile 001(801) 682 0898
E-Mail mike.sehgal@gebhardtfans.com
<http://www.gebhardtfans.com/>

Nicotra Gebhardt Italien

Nicotra Gebhardt S.p.A
Via Modena, 18
24040 Zingonia (BG)
Italien
Telefon +39 035 873 111
Telefax +39 035 884 319
E-Mail info@nicotra-gebhardt.com

NICOTRA | **Gebhardt**
fan|tastic solutions